

SCA1350A

150 UST (136 mt)
Crawler Crane

SANY



Max Boom Length: 249.3ft (76m)
Max Fixed Jib Combination: 200.1ft + 101.7ft (61m + 31m)
Max Luffing Jib Combination: 160.8ft + 170.6ft (49m + 52m)

The parameters and diagrams in the brochure is only for reference, which is subject to further update in real machine.



SCA1350A

Sany Crawler Crane

P02

Main Characteristics

- Product Specification
- Safety Device

P08

Technical Parameters

- Major Performance & Specifications
- Outline Dimension
- Transport Dimension

P16

Configurations

- H Configuration
- Hh Configuration
- FJ Configuration
- LJ Configuration



SCA1350A
SANY CRAWLER CRANE
150 UST (136 mt) LIFTING CAPACITY
MADE FOR AMERICA

Main Characteristics

- Page 03 Product Specification
- Page 06 Safety Device

Product Specification



Engine

- Model: Cummins QSL9-C325 Diesel engine;
- Type: 4-stroke, water-cooled, vertical in-line 6 cylinders, direct injection, turbo-charger, intercooler, complied with European Off-highway Stage V Emission Standard and US EPA Tier F4(f) Emission Standard;
- Displacement: 543 in³ (8.9L);
- Max. Rated Power: 325 HP/1800rpm;
- Max. Torque: 1,126 ft-lb/1400rpm;
- Starter: 24V-8 HP;
- Radiator: fin type aluminum plate core;
- Air cleaner: Dry type system with main filter element, safety element and resistance indicator;
- Throttle: Electrically controlled hand and foot throttle;
- Fuel filter: Replaceable paper element;
- Batteries: Two 12V×180Ah capacity batteries, connected in series (24V system);
- Fuel tank capacity: 105.7Gal (400L).

Hydraulic System

- Main pumps: Three variable displacement piston pumps provide power for the main machine functions;
- Gear Pumps: Two gear pumps provide power for radiator and control circuit;
- Control: Electrically controlled positive hydraulic flow control allows for safe and precise multifunction operation;
- Oil Cooler: Fan cooled heat exchanger provides multi stage hydraulic oil cooling;
- Filter: Peak flow, high efficiency filter with bypass valve and replacement filter indicator. Indicator will remind user when its time to replace filter;
- Max. pressure of system: 4,641 psi;
- Main/aux. hoist and travel system: 4,641 psi;
- Swing system: 4,641 psi;
- Control system: 725 psi;
- Hydraulic Tank Capacity: 121.5Gal (460L).

Electrical Control System

- Self developed SYIC II control system is highly integrated to provide safe, precise, and reliable operation;
- Control system consists of power system, engine system, main control system, LMI system, auxiliary system and safety monitoring system. CAN BUS is used for data communication between controller, monitor and the engine;

- The in cab monitor display the status and working parameters for engine speed fuel level, engine oil pressure, pilot pressure, engine hours, boom configuration, hook radius, hook height, boom angle, wind speed, load on hook, and safety warnings.

Main and Aux. Hoist Winch

- Main and aux. hoist winches are driven separately by a variable speed hydraulic motor and gearbox. Single axis control handles allow for power up/down and free fall winch operations. Fine inching control is standard and allows for precise operation;
- Winch drum laggings are grooved for multilayer spooling;
- **Main hoist/Aux. hoist with free fall function:**

Main hoisting winch	Drum diameter	22.68in (576mm)
	Rope speed (1st layer)	0~397.0ft/min (0~121m/min)
	Wire rope diameter	1.02in (26mm)
	Main hoist wire rope length	984' (300m)
	Rated single line pull	26.5Klb (12t)
Aux. hoisting winch	Drum diameter	22.68in (576mm)
	Rope speed (1st layer)	0~397.0ft/min (0~121m/min)
	Wire rope diameter	1.02in (26mm)
	Aux. hoist wire rope length	853' (260m)
	Rated single line pull	26.5Klb (12t)

- **Main hoist/Aux. hoist without free fall function:**

Main hoisting winch	Drum diameter	24.80in (630mm)
	Rope speed (1st layer)	0~397.0ft/min (0~121m/min)
	Wire rope diameter	1.02in (26mm)
	Main hoist wire rope length	984' (300m)
	Rated single line pull	26.5Klb (12t)
Aux. hoisting winch	Drum diameter	24.80in (630mm)
	Rope speed (1st layer)	0~397.0ft/min (0~121m/min)
	Wire rope diameter	1.02in (26mm)
	Aux. hoist wire rope length	853' (260m)
	Rated single line pull	26.5Klb (12t)



Product Specification

Boom Hoist Winch

- Boom hoist winch is driven directly by a variable speed hydraulic motor and gearbox. Single axis control handle allows for boom up/down operations;
- Spring loaded brake is hydraulic released;
- Winch drum laggings are grooved for multilayer spooling.

Boom hoist winch	Drum diameter	16.54 in (420mm)
	Rope speed (1st layer)	0~147.6ft/min (0~45m/min)
	Diameter of wire rope	0.79 in (20mm)
	Boom hoist wire rope length	623.3' (190m)

Swing Mechanism

- Swing Brake: Spring applied wet brake that is normally closed, providing controlled smooth braking;
- Swing system has three work modes to accommodate different needs: auto brake mode, free swinging mode, and fine inching mode;
- Swing drive: external engaged swing drive with 360° swing range, max. swing speed is 2.2 rpm;
- Swing bearing: three-row roller bearing.

Cab and Control

- Operators cab has a hinged lockable door and large windows providing excellent line of sight. The cab tilts up 20° providing the operator a panorama view and reducing fatigue. The cab and control layout allow for ergonomic operation keeping the operator comfortable;
- Monitor: 10.4 touch screen with simple user friendly interface;
- Armrest Console: Control handles electrical switches, emergency stop, and ignition switch are located on the left and right. Arm console can be adjusted independent of the seat;
- Seat: Multi-way adjustable floating seat;
- HVAC: Powerful air conditioner and heater with optimized vent locations;
- Cameras: Multiple cameras can be displayed on the monitor at the same time. This provides the operator with a real time view of winches, right side of machine, rear of machine, and view from boom tip;
- Single axis controls for travel, main, aux, and boom hoist winches. Dual axis controls for swing and 3rd drum operation.

Counterweight

- Counterweight tray and blocks nest together for easy assembly, disassembly and transportation;
- Rear counterweight: total weight 119.0Klb (54mt), 11.6Klb (5.25mt) counterweight blocks x 8, 26.5Klb (12mt) counterweight tray x1;
- Carbody counterweight: A total of 2, total weight of 44.1Klb (20mt) [22.05Klb*2 (10t x 2)];

Upperworks

- High-strength steel welded frame. Design allows for easy maintenance and service.

Product Specification



Crawler Assembly

- Each side frame is equipped with an independent travel driving motor. The variable speed travel system is configured with speed options to meet various requirements: low speed provides max tractive effort, while high speed provides fast job site transfer.

Crawler Tensioning

- Crawler tensioning can be adjustable with hydraulic jack and shimming the guide wheel.

Track Pad

- Manufactured by advance casting techniques and materials providing high strength and excellent wear resistance;
- 37.4in (950mm) wide and each side frame has 64 track pads.

Jack Cylinder

- Standard jack cylinders make jobsite transport easier.

Operating Equipment

- All chords are high-strength steel tubes, and the boom/jib head sheaves are made of high-strength anti-wearing Nylon material protecting wire rope. The hook blocks have grooved steel sheaves.

Boom

- Lattice structure with high-strength steel chords. Each section is pinned together with pins;
- The length of the boom ranges from that (52.5ft/16m) of the basic boom to the maximum length (249.3ft/76m) and it can be incrementally changed by 9.8ft (3m).

Fixed Jib

- Lattice structure with high-strength steel chords. Each section is pinned together with pins;
- The length of the fixed jib ranges from that (42.7ft/13m) of the basic jib to the maximum length (101.7ft/31m) and it can be incrementally changed by 9.8ft (3m).;
- Longest boom + fixed jib: 200.1ft (61m) + 101.7ft (31m).

Luffing jib

- Lattice structure with high-strength steel chords. Each section is pinned together with pins;
- The length of the luffing jib ranges from that (72.2ft/22m) of the basic jib to the maximum length (170.6ft/52m) and it can be incrementally changed by 9.8ft (3m).
- Longest boom +luffing jib 160.8ft (49m)+170.6ft (52m).

Auxiliary Tip Extension

- Is a welded structure with one sheave that is connected to the main boom with with pins. It is used for aux. hook operations;
- Length of auxiliary tip extension: 8.9ft (2.7m).

Hook Block

- 150 UST hook, 5 sheaves;
- 88 UST hook, 3 sheaves;
- 39 UST hook, 1 sheave;
- 15 UST ball hook.

Safety Device



Assembly/Work Mode Control Switch

- In assembly mode, some of the safety devices are bypassed for helping crane assembly, for example, jib lower limit, boom angle limit and overload;
- In work mode, all safety devices are active.

Emergency Stop

- When this button is pressed down power supply to whole machine is cut off and all actions are stopped.

Load Moment Indicator (LMI)

- The proprietary load moment indicator is independently -developed by Sany, which is a specially designed over-load protective system for SCA series crawler crane, with performance structural parameters of all series of crawler cranes directly stored inside, such as bearing curve, boom and jib weight, center of gravity, and other geometrical parameters. This system maximizes the utilization efficiency of the crane while guaranteeing the lifting safety;
- The independent safety control system fully controlled by computer, the LMI can automatically detect the load weight, work radius, and boom angle, compare rated capacity with actual load, actual radius and actual boom angle. In normal operation, the LMI can intelligently determine and cut off the crane from dangerous operation. It also has a black box function and record overload information;
- LMI consists of a 10.1in large colorful display, computer, angle sensors, load sensors and pressure sensors.

Over-hoist Limit Switch of Main/Auxiliary Hooks (Anti Two Block)

- It is used to prevent the over-hoist of the hook. When the lifting hook is raised to a certain height, the limit switch will be activated, and hook hoisting will be automatically cut off by the control system.
- Warning will be displayed in monitor and alarm will sound. At this moment, only hook lowering is allowed to prevent over-hoist action.

Over-release Limit Switch of Main/Auxiliary Hooks (Third Wrap Indicator)

- It is used to prevent the wire rope over-release. When the wire rope is released to the last three wraps, the limit switch will activate, and the releasing of rope will be automatically stopped by the control system. Warning will be displayed in monitor and alarm will sound. At this moment, only rope retraction is allowed to prevent over release action.

Function Lock Lever

- If the function lock level is not in work position, all the other handles won't work, which prevents any mis-operation caused by control handle movement.

Boom Hoist Drum Lock

- Pawl lock is used on boom hoist winch, which needs to unlock by switch before operation, in order to prevent mis-operation of handles and ensure safety during nonwork time.

House Lock Device

- House Lock can lock the machine at four positions, front, back, left and right.

Boom Limit Device

- When the boom angle exceeds 85° or jib angle exceeds 75°, corresponding limit switch will be triggered, and the control system will automatically cut off the boom hoisting. Warning will be displayed in monitor and alarm will sound. At this moment, boom/jib luffing winch won't hoist but it can still lower down.
- When the boom angle is less than 30° or jib down angle is less than 15°, the control system will automatically cut off the boom/jib from further lowering. Warning will be displayed in monitor and alarm will sound. At this moment, boom/jib luffing winch won't be able to lower. This protection is automatically controlled by Load Moment Indicator.

Back-stop Device

- Its major components are nesting tubes and spring, in order to buffer the boom and prevent boom overhaul.

Boom Angle Indicator

- Pendulum angle indicator is fixed on the side of boom base close to the cab, so as to provide convenience to the operator.

Hook Latch

- The hook is provided with a baffle to prevent wire rope from falling off.

Safety Device



Zoom Camera

- It can monitor load lifting on the main hook and the surroundings in real time. The camera can zoom in/out as needed.
- Components: wireless remote transmitter, wireless remote receiver, zoom camera.

Tri-color Load Indicator

- The load indication light has three colors, green, yellow and red, and the real time load status is presented on the display. When the actual load is smaller than 90% of rated load, the green light is on;
- When the actual load is larger than 90% and smaller than 100%, the yellow light is on, the alarm light flashes and sends out intermittent sirens;
- When the actual load reaches 100% of rated load, the red light is on, the alarm light flashes and sends out continuous sirens;
- When the actual load reaches 102% of rated load, the system will automatically cut off the crane operation.

Audio-visual Alarm

- Lights flash when the engine is running. During travel and swinging and audible alarm is sounded.

Swing Indicator Light

- The swing indicator light flashes during traveling or swing.

Illuminating Light

- The machine is equipped with the low beam light and high beam light at the front of the cab, illumination light in cab, and other lights for night operation, boom lights to improve the visibility during operation.

Rear View Mirror

- It is installed on the left of the operator's cab for monitoring the rear part of the machine.

Pharos (Aircraft Warning Light)

- Light mounted on the top of boom/jib that flashes at night.

Anemometer

- It is mounted on the top of boom/jib, and displays the wind speed on the monitor in the cab.

Electronic Level Indicator

- It displays the tipping angle of crane on the monitor in real time, protecting the machine from dangerous situation.

Seat Interlock

- If the function lever lock is lowered on the left side of cab seat or if the operator leaves the seat, all control levers will be deactivated to prevent any mis-operation due to accidental control handle movement.

Engine Power Limit Load Adjustment and Stalling Protection

- The controller monitors the engine power to prevent engine stalling.

Engine Status Monitoring

- The engine parameters will be displayed in the monitor, such as engine coolant temperature, fuel level, total engine hours, engine oil pressure, engine speed, battery, voltage.



SCA1350A
SANY CRAWLER CRANE
150 UST (136 mt) LIFTING CAPACITY

MADE FOR AMERICA

Technical Parameters

- Page 10 Major Performance Specifications
- Page 11 Outline Dimension
- Page 12 Transport Dimension
- Page 17 Transportation Plan



Major Performance Specifications

Major Performance & Specifications of SCA1350A			
Performance Indicators		Unit	Parameter
Boom configuration	Maximum rated lifting capacity	Klb (mt)	300 (136)
	Maximum rated lifting moment	Klb*ft (mt*m)	210.3*23 (95.4 * 7)
	Boom length	ft (m)	52.5~249.3 (16~76)
	Boom Angle	°	30~85
Fixed jib configuration	Maximum rated lifting capacity	Klb (mt)	59.5 (27)
	Jib length	ft (m)	42.7~101.7 (13~31)
	Longest main boom + jib	ft (m)	200.1+101.7 (61+31)
	Jib angle offset	°	10, 30
Luffing jib configuration	Maximum rated lifting capacity	Klb (mt)	88.2 (40)
	Jib length	ft (m)	72.2~170.6 (22~52)
	Longest main boom + jib	ft (m)	160.8~170.6 (49+52)
Operation speed	Rope speed of main/aux. hoist (1st layer)	ft/min (m/min)	397.0 121
	Rope speed of boom hoist (1st layer)	ft/min (m/min)	147.6 45
	Swing speed	rpm	2.2
	Travel speed	mile/h (km/h)	0.8 1.3
Engine	Output power	HP	325
	Rated speed	rpm	1800
Transport parameter	Weight of machine with basic boom (including basic boom, extension jib, jib luffing winch, 150 UST hook and 15 UST hook)	Klb (mt)	329.2 (149.34)
	Maximum transport weight of basic machine (including base)	Klb (mt)	88.2 (40)
	Maximum transport dimension of basic machine (L x W x H)	ft (m)	52.7*9.8*10.7 (16.1x3x3.3)
Other parameters	Average ground bearing pressure	PSI	16
	Grade ability	%	30

Unit: ft (mm)

Outline Dimension

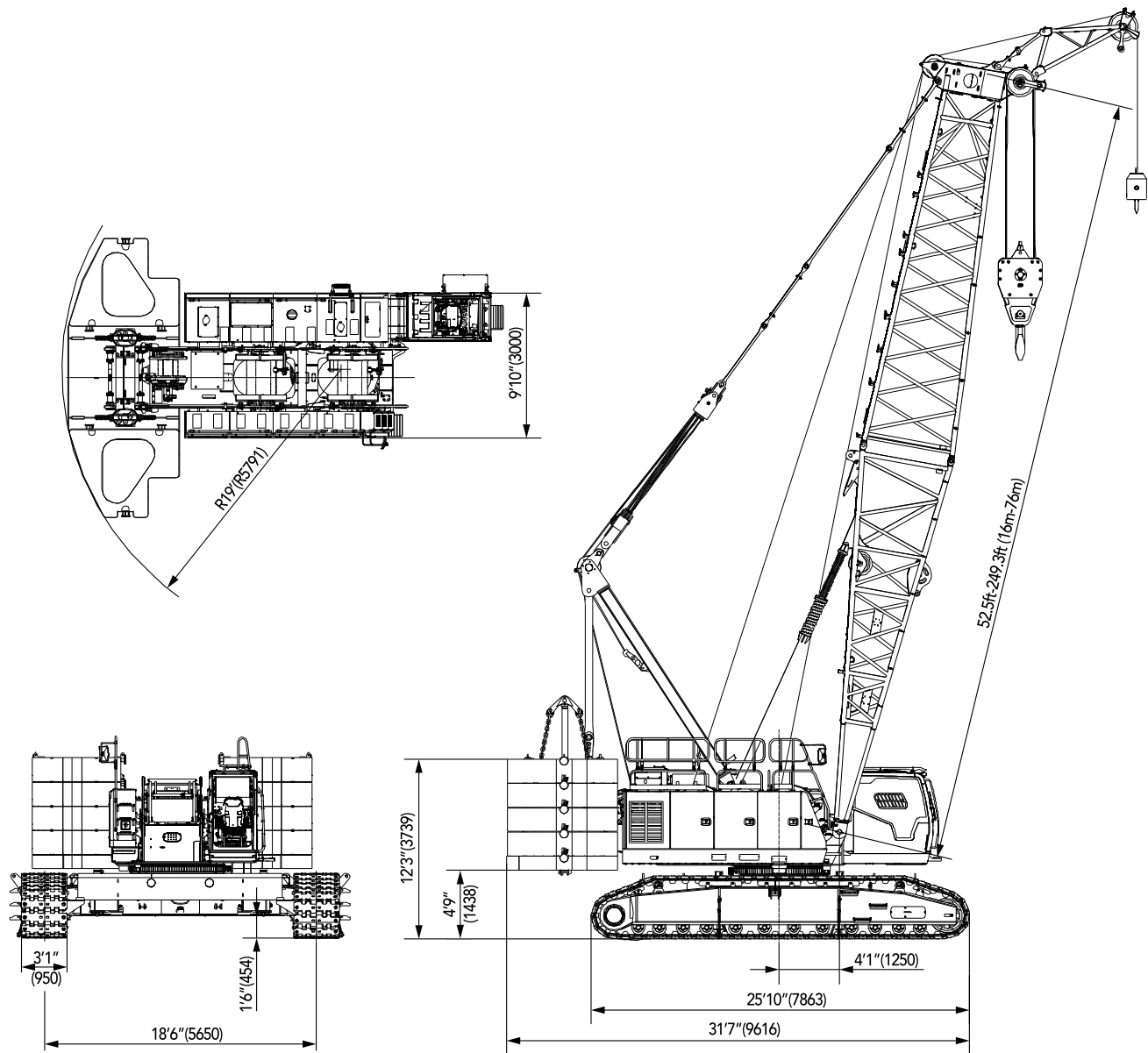

Transportation Dimensions

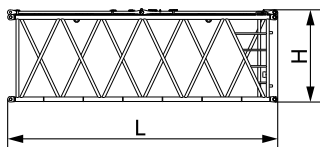
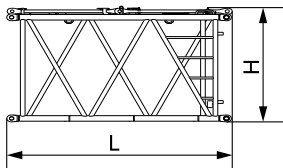
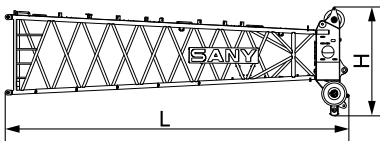
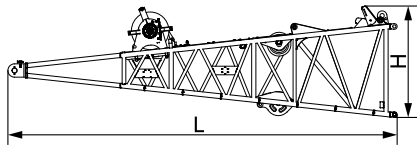
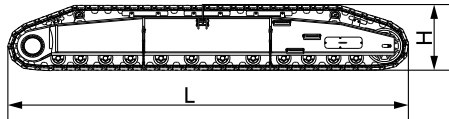
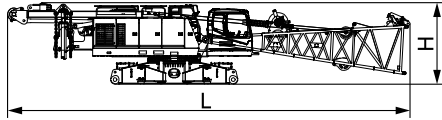

Basic machine (with boom base and jib luffing winch) ×1

Length (L)	52.7ft (16.05m)
Width (W)	9.8ft (3.00m)
Height (H)	10.7ft (3.25m)
Weight	88.2Klb (40mt)

Note: the weight of jib luffing winch and wire rope is 4.14Klb (1.88mt)

Crawler assembly ×2

Length (L)	25.8ft (7.86m)
Width (W)	4.3ft (1.32m)
Height (H)	4.3ft (1.32m)
Weight	33.1Klb (15mt)

Boom base (with jib luffing winch) ×1

Length (L)	26.9ft (8.21m)
Width (W)	6.8ft (2.08m)
Height (H)	7.3ft (2.24m)
Weight	12.7Klb (5.78mt)

Note: the weight of jib luffing winch and wire rope is 4.14Klb (1.88mt)

Boom top ×1

Length (L)	27.6ft (8.42m)
Width (W)	6.4ft (1.96m)
Height (H)	8.7ft (2.66m)
Weight	5.6Klb (2.55mt)

3m insert of main boom ×1

Length (L)	10.3ft (3.15m)
Width (W)	6.8ft (2.06m)
Height (H)	6.9ft (2.09m)
Weight	1.4Klb (0.62mt)

6m insert of main boom ×2

Length (L)	20.1ft (6.14m)
Width (W)	6.8ft (2.06m)
Height (H)	6.8ft (2.08m)
Weight	2.3Klb (1.04mt)

Transportation Dimensions

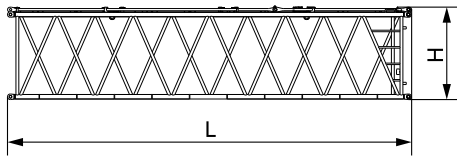

9m insert of main boom

×5

Length (L)	30.0ft (9.14m)
Width (W)	6.8ft (2.06m)
Height (H)	6.8ft (2.08m)
Weight	3.3Klb (1.49mt)

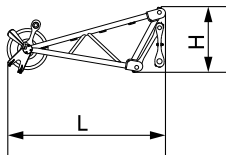

Auxiliary tip extension

×1

Length (L)	7.7ft (2.36m)
Width (W)	3.4ft (1.04m)
Height (H)	3.2ft (0.98m)
Weight	0.7Klb (0.3mt)

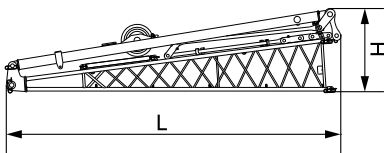

Fixed jib base(including strut)

×1

Length (L)	17.2ft (5.25m)
Width (W)	3.9ft (1.19m)
Height (H)	4.3ft (1.30m)
Weight	1.9Klb (0.84mt)

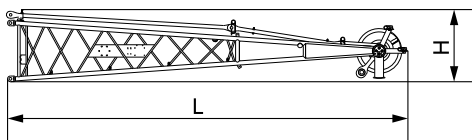

Fixed jib top

×1

Length (L)	17.8ft (5.43m)
Width (W)	3.3ft (1.01m)
Height (H)	3.2ft (0.99m)
Weight	1.2Klb (0.53mt)

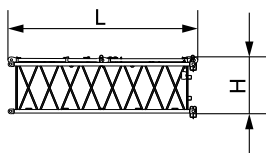

3m insert of fixed jib

×1

Length (L)	10.2ft (3.12m)
Width (W)	3.3ft (1.02m)
Height (H)	3.0ft (0.92m)
Weight	0.4Klb (0.19mt)

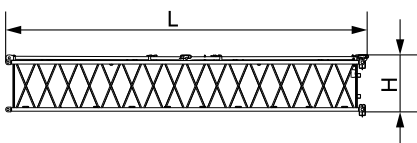

6m insert of fixed jib

×3

Length (L)	20.1ft (6.12m)
Width (W)	3.3ft (1.02m)
Height (H)	3.0ft (0.92m)
Weight	0.7Klb (0.34mt)

Transportation Dimensions

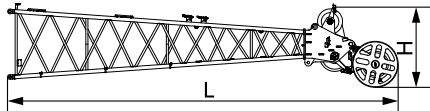

Luffing jib top

×1

Length (L)	25.6ft (7.81m)
Width (W)	4.5ft (1.38m)
Height (H)	4.8ft (1.45m)
Weight	2.6Klb (1.17mt)

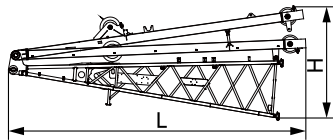

Luffing jib base (with struts)

×1

Length (L)	23.8ft (7.26m)
Width (W)	6.1ft (1.87m)
Height (H)	8.9ft (2.7m)
Weight	6.9Klb (3.13mt)

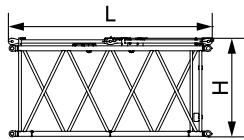

3m luffing jib insert

×2

Length (L)	10.2ft (3.1m)
Width (W)	4.6ft (1.4m)
Height (H)	4.9ft (1.5m)
Weight	0.7Klb (0.3mt)

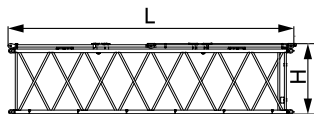

6m luffing jib insert

×1

Length (L)	20.0ft (6.1m)
Width (W)	4.6ft (1.4m)
Height (H)	4.9ft (1.5m)
Weight	1.1Klb (0.49mt)

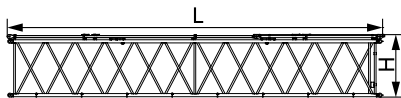

9m luffing jib insert

×3

Length (L)	29.9ft (9.1m)
Width (W)	4.6ft (1.4m)
Height (H)	5.2ft (1.6m)
Weight	1.5Klb (0.7mt)

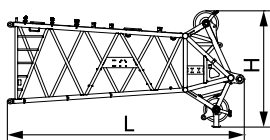

Boom top (special for L)

×1

Length (L)	18.7ft (5.7m)
Width (W)	6.4ft (1.95m)
Height (H)	9.2ft (2.8m)
Weight	4.2Klb (1.9mt)

Transportation Dimensions

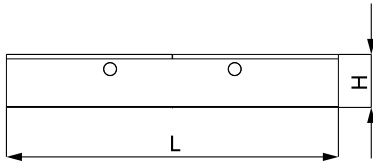

Carbody counterweight

×2

Length (L)	13.9ft (4.25m)
Width (W)	4.9ft (1.5m)
Height (H)	1.8ft (0.55m)
Weight	22.0Klb (10t)

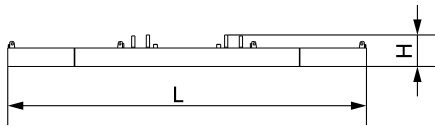

Rear counterweight tray

×1

Length (L)	19.0ft (5.8m)
Width (W)	7.6ft (2.31m)
Height (H)	1.6ft (0.5m)
Weight	26.5Klb (12mt)

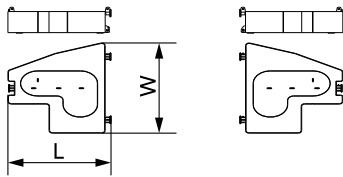

Rear counterweight

(1+1)×4

Length (L)	6.3ft (1.93m)
Width (W)	7.5ft (2.28m)
Height (H)	2.0ft (0.6m)
Weight	11.6Klb (5.25mt)

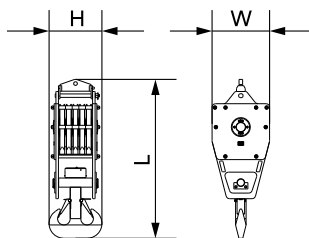

150 UST lifting hook

×1

Length (L)	7.5ft (2.28m)
Width (W)	3.0ft (0.91m)
Height (H)	2.3ft (0.69m)
Weight	4.5Klb (2.04mt)

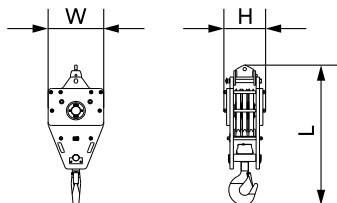

88 UST lifting hook

×1

Length (L)	7.3ft (2.21m)
Width (W)	3.0ft (0.91m)
Height (H)	2.0ft (0.62m)
Weight	4.3Klb (1.94mt)

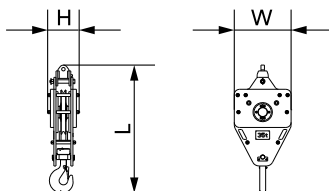

39 UST lifting hook

×1

Length (L)	6.2ft (1.88m)
Width (W)	3.0ft (0.91m)
Height (H)	1.5ft (0.46m)
Weight	2.6Klb (1.2mt)

Transportation Dimensions

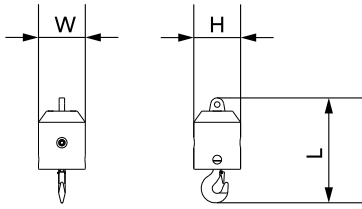

15 UST ball hook

×1

Length (L)	3.1ft (0.95m)
Width (W)	1.4ft (0.43m)
Height (H)	1.4ft (0.43m)
Weight	1.0Klb (0.45mt)

Remarks:

1. The transport dimensions for the parts are for reference that do not draw to the scale. The dimensions listed above are designed values excluding packing.
2. Weight is design values. It maybe different due to manufacturing tolerances.



SCA1350A
SANY CRAWLER CRANE
150 UST (136 mt) LIFTING CAPACITY

MADE FOR AMERICA

Configurations

- Page 17 Boom Combination
- Page 20 H Configuration
- Page 21 H Working Radius
- Page 22 H Load Chart
- Page 28 Hh Configuration
- Page 29 Hh Working Radius
- Page 30 Hh Load Chart
- Page 31 FJ Configuration
- Page 32 FJ Working Radius
- Page 33 FJ Load Chart
- Page 37 LJ Configuration
- Page 38 LJ Working Radius
- Page 39 LJ Load Chart



Boom Combination

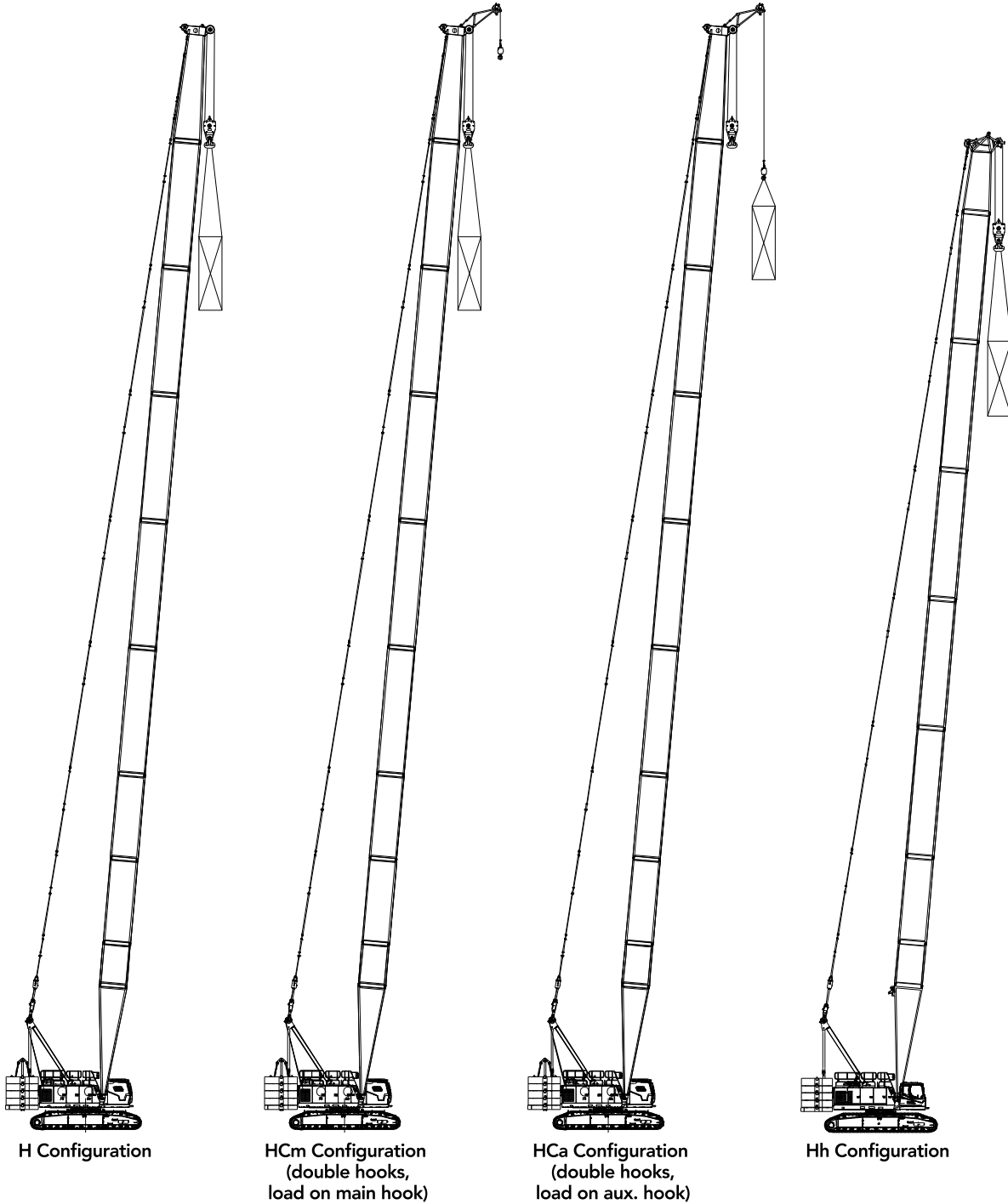

Configuration	Boom Combination	Boom Length
H	Boom	52.5ft~249.3ft (16m~76m)
HCm	Boom + aux tip extension (double hooks, load on main hook)	
HCa	Boom + aux tip extension (double hooks, load on aux. hook)	
Hh	Boom (with boom top special for LJ)	72.2ft~219.8ft (22m~67m)

Note: The schematics above are reference for loading only.

Boom Combination

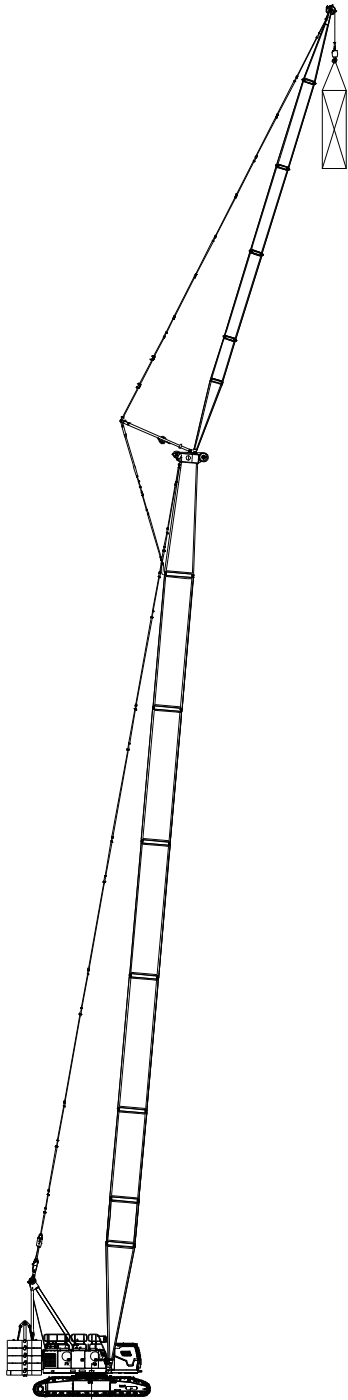

FJ Configuration
(single hook)

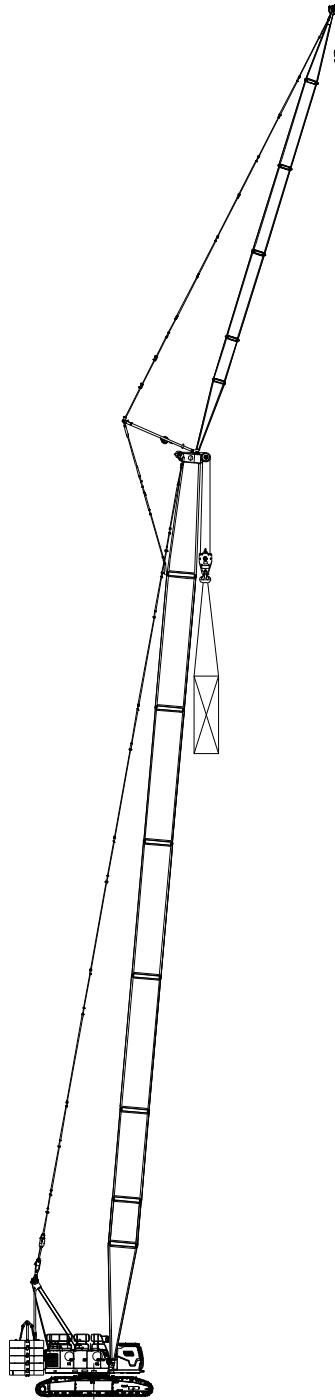

FJm Configuration
(double hooks, load on main hook)

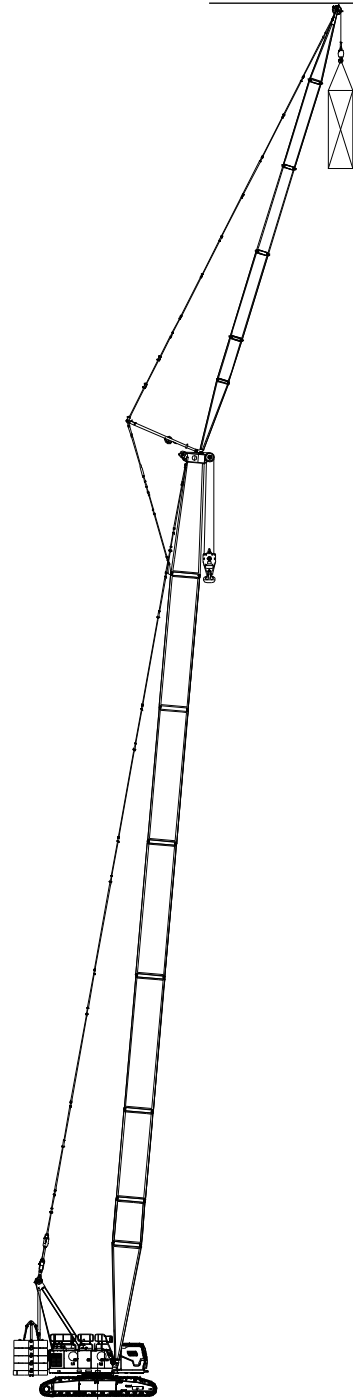

FJa Configuration
(double hooks, load on aux. hook)

Configuration	Boom Combination	Boom Length
FJ	Boom + Fixed jib (single hook)	
FJm	Boom + Fixed jib (double hooks, load on main hook)	(72.2ft~200.1ft)+(42.7ft~101.7ft)
FJa	Boom + Fixed jib (double hooks, load on aux. hook)	(22m~61m)+(13m~31m)

Note: The schematics above are reference for loading only.

Boom Combination

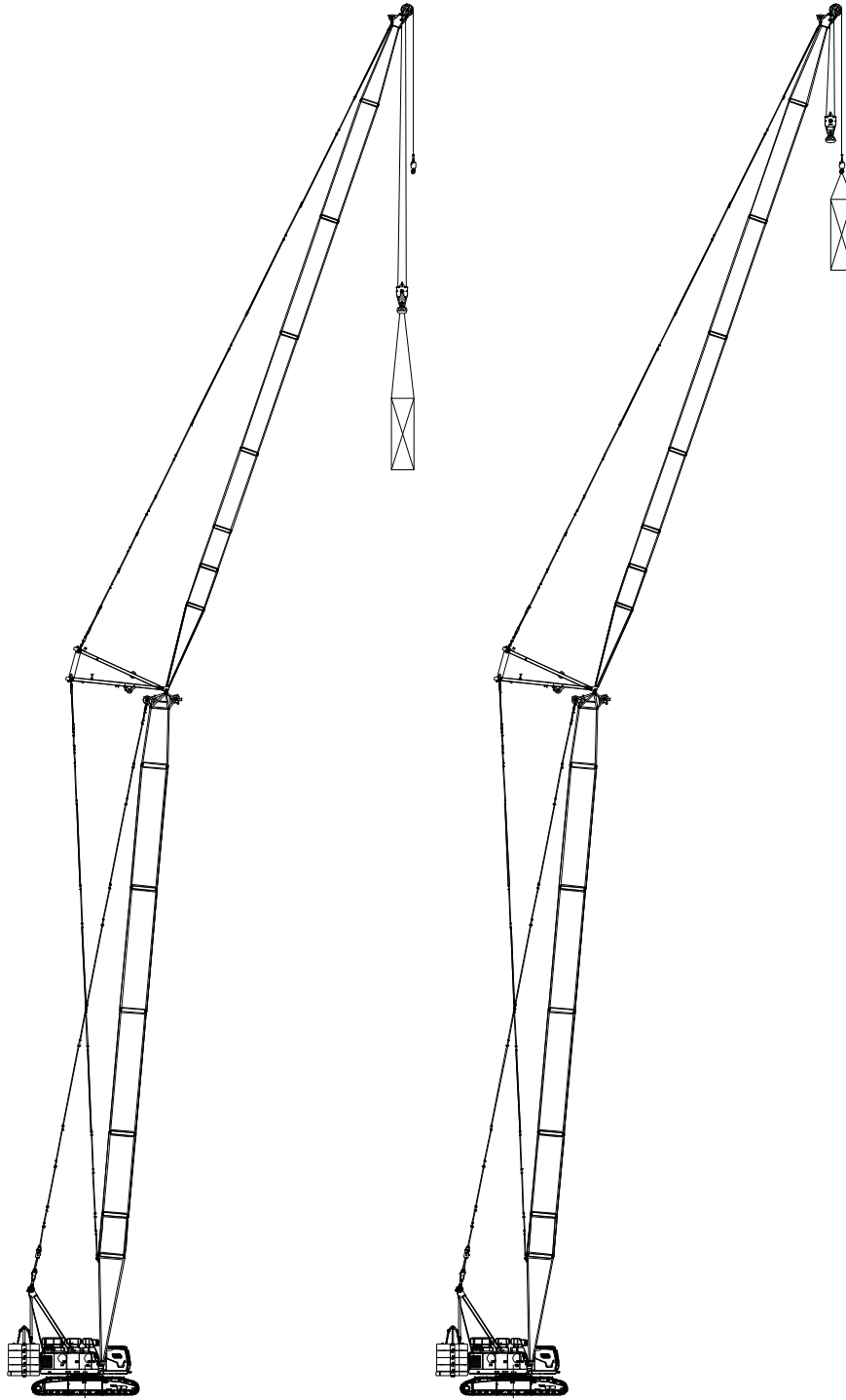

LJ Configuration (double hooks, load on luffing jib hook) **LJa Configuration** (double hooks, load on aux tip extension hook)

Configuration	Boom Combination	Boom Length
LJ	Boom + Luffing jib (double hooks, load on luffing jib hook)	160.8ft+170.6ft (49m+52m)
LJa	Boom + Luffing jib (double hooks, load on aux tip extension hook)	

Note: The schematics above are reference for loading only.

H Configuration

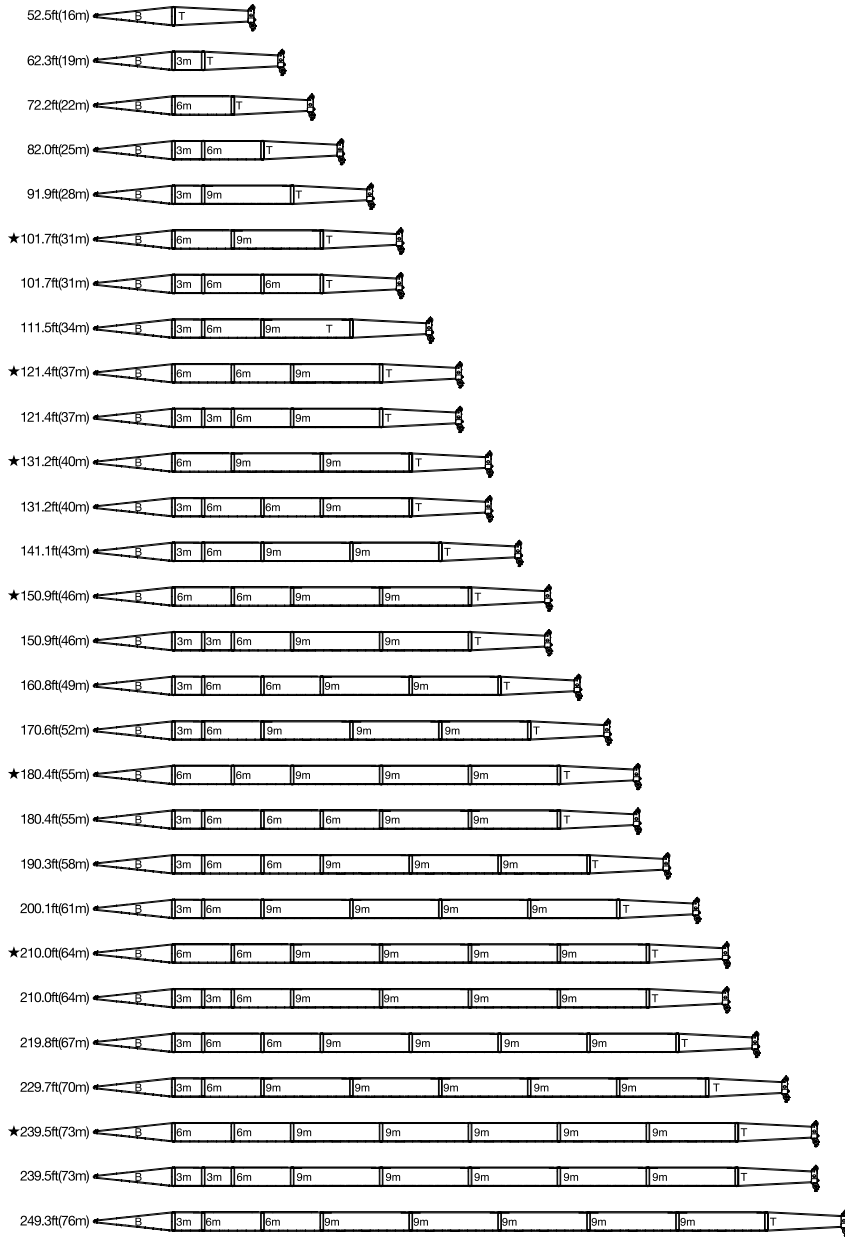

Note: The boom combinations with "★" are recommended for configuration.

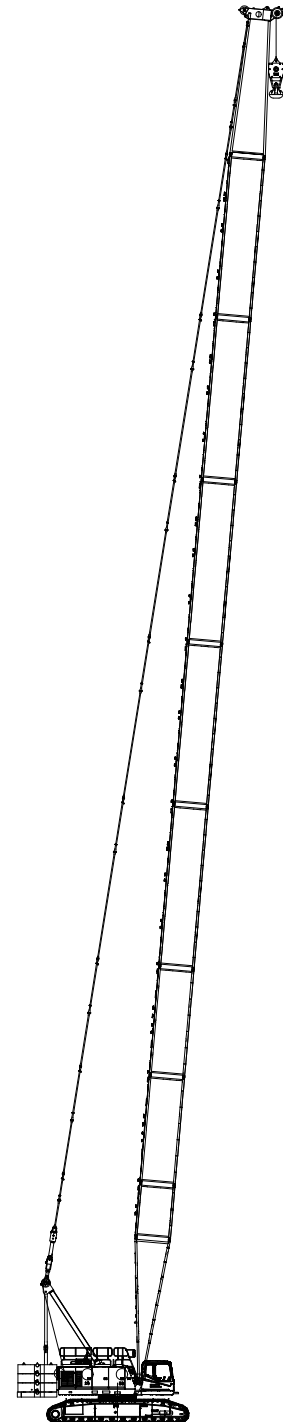
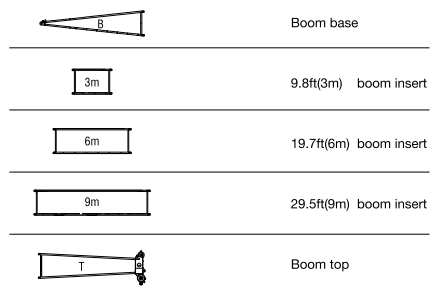

H Configuration:
52.5ft~249.3ft(16m~76m)

H Working Radius

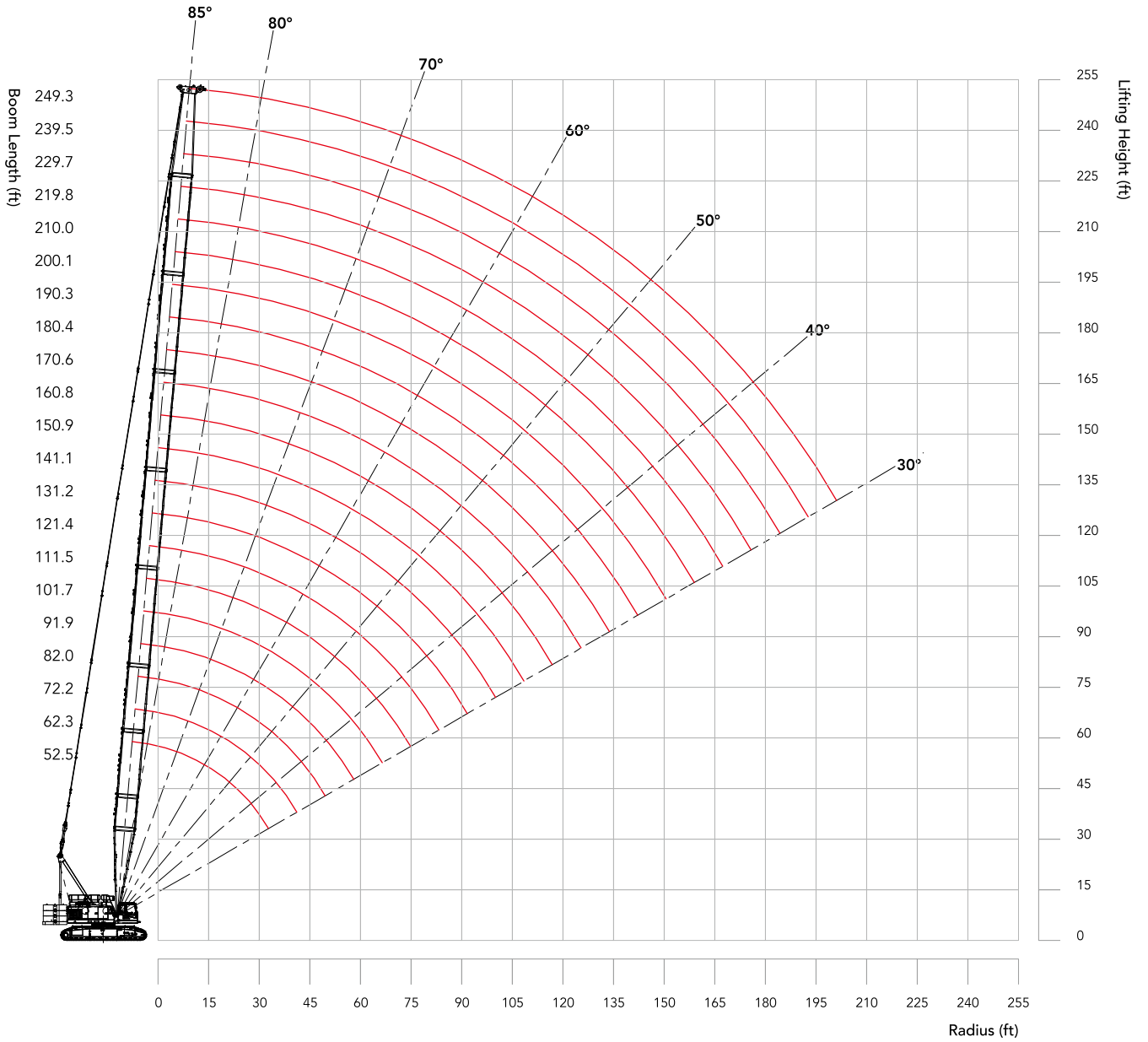

Unit:klb

H Load Chart

Note:

1. The rated load in the load chart is calculated complying with ASME B30.5;
2. The working radius is the horizontal distance from the load center to the swing center;
3. The actual lifting capacity must subtract the weight of hooks and other riggings from the rated capacity in the load chart.
4. The load value is calculated when the object is hung freely,without considering the influence of wind on the load, ground conditions and slope, operation speed and the influence of any other negative factors over safe operation. Therefore, the operator bears the responsibility of making a judgement and decreasing the load and lowering speed.
5. All ratings are calculated when the machine is parking on firm and level ground with less than 1% gradient.
6. See the Operation Manual for the complete load charts of HCm and HCa configurations.

SCA1350A crawler crane - H configuration load chart 1/6

Main hook, Boom 52.5~249.3ft, without aux tip extension

Boom length (ft)	52.5					62.3					72.2					Boom length (ft)	
	Counterweight (klb)	119.0+441	95.9+0	72.8+0	26.5+0	0+0	119.0+441	95.9+0	72.8+0	26.5+0	0+0	119.0+441	95.9+0	72.8+0	26.5+0		0+0
Radius (ft)																Radius (ft)	
15	300	-	-	-	-	-	-	-	-	-	-	-	-	-	-	-	15
16	291.4	-	-	-	-	-	-	-	-	-	-	-	-	-	-	-	16
17	279.0	-	-	-	-	277.0	-	-	-	-	-	-	-	-	-	-	17
18	264.9	-	-	-	-	263.2	-	-	-	-	-	-	-	-	-	-	18
19	250.7	-	-	-	-	249.4	-	-	-	-	-	-	-	-	-	-	19
20	238.4	226.3	183.0	129.8	86.8	236.7	-	-	-	-	235.2	-	-	-	-	-	20
22	218.8	201.6	162.2	118.1	79.9	214.0	-	-	-	-	212.6	-	-	-	-	-	22
24	199.3	178.0	142.8	105.3	71.5	194.8	176.8	141.8	104.5	71.1	193.4	173.3	139.6	103.2	69.8	24	
26	180.0	155.3	124.5	91.6	62.0	178.2	154.2	123.6	90.9	61.5	176.7	153.1	122.7	90.4	61.2	26	
28	166.6	139.3	111.6	82.0	55.3	165.2	138.3	110.9	81.3	54.9	163.8	137.6	110.1	80.9	54.6	28	
30	154.5	125.1	100.1	73.5	49.4	153.2	124.3	99.5	72.8	48.9	151.9	123.6	98.9	72.4	48.7	30	
32	144.3	113.9	91.0	66.7	44.6	143.1	113.2	90.5	66.1	44.4	142.0	112.6	90.0	65.8	44.0	32	
34	135.5	105.1	83.8	61.4	40.9	134.5	104.5	83.3	60.8	40.7	133.4	103.9	82.9	60.5	40.3	34	
36	127.6	97.5	77.8	56.8	37.8	126.6	96.9	77.2	56.3	37.6	125.7	96.4	76.8	56.0	37.1	36	
38	119.7	89.9	71.7	52.3	34.6	118.7	89.4	71.1	51.8	34.4	118.0	88.9	70.7	51.4	34.0	38	
40	112.3	83.3	66.4	48.3	31.9	111.4	82.9	65.8	47.9	31.6	110.8	82.4	65.4	47.4	31.2	40	
45	96.3	71.2	56.5	40.9	26.8	95.6	70.6	56.1	40.5	26.4	95.2	70.3	55.6	40.2	26.2	45	
50	-	-	-	-	-	83.6	61.6	48.7	34.9	22.6	83.2	61.2	48.3	34.7	22.4	50	
55	-	-	-	-	-	73.9	54.2	42.8	30.5	19.5	73.4	53.9	42.3	30.2	19.3	55	
60	-	-	-	-	-	-	-	-	-	-	65.5	47.9	37.5	26.5	16.8	60	
65	-	-	-	-	-	-	-	-	-	-	59.1	43.0	33.7	23.7	14.8	65	
Parts of line	12	9	8	5	4	11	8	6	5	3	10	7	6	5	3	Parts of line	

H Load Chart

SCA1350A crawler crane - H configuration load chart 2/6																
Main hook, Boom 52.5~249.3ft, without aux tip extension																
Boom length (ft)	82					91.9					101.7					Boom length (ft)
Counterweight (klb) Radius (ft)	119.0+ 441	95.9+0	72.8+0	26.5+0	0+0	119.0+ 441	95.9+0	72.8+0	26.5+0	0+0	119.0+ 441	95.9+0	72.8+0	26.5+0	0+0	Counterweight (klb) Radius (ft)
20	234.6	-	-	-	-	-	-	-	-	-	-	-	-	-	-	20
22	212.3	-	-	-	-	-	-	-	-	-	-	-	-	-	-	22
24	192.9	169.5	136.5	100.8	68.1	189.7	-	-	-	-	183.3	-	-	-	-	24
26	176.4	152.8	122.5	90.1	60.8	174.1	-	-	-	-	168.3	-	-	-	-	26
28	163.2	137.6	110.1	80.8	54.4	161.7	135.0	108.3	79.4	53.3	156.4	132.0	106.0	77.8	51.7	28
30	151.1	123.5	98.6	72.3	48.5	150.2	122.6	98.0	71.6	48.1	145.5	121.0	97.0	71.0	47.1	30
32	141.1	112.5	89.8	65.5	43.9	140.1	111.7	89.1	65.0	43.5	136.4	110.8	88.5	64.5	42.9	32
34	132.6	103.6	82.6	60.1	40.2	131.6	102.9	82.0	59.7	39.8	128.7	102.3	81.5	59.3	39.4	34
36	125.0	96.1	76.5	55.6	37.1	124.1	95.6	76.0	55.3	36.6	122.0	95.0	75.5	54.9	36.3	36
38	117.4	88.6	70.5	51.1	33.9	116.6	88.2	70.0	50.9	33.5	115.3	87.7	69.6	50.4	33.2	38
40	110.3	82.0	65.1	47.1	31.1	109.6	81.6	64.7	46.9	30.7	108.8	81.1	64.3	46.5	30.4	40
45	94.8	69.9	55.4	39.9	25.9	94.3	69.5	54.9	39.5	25.6	93.8	69.0	54.7	39.3	25.4	45
50	82.8	60.8	48.0	34.3	22.0	82.3	60.4	47.7	34.0	21.8	81.9	60.0	47.3	33.7	21.5	50
55	73.0	53.5	42.0	29.9	18.9	72.6	53.1	41.8	29.6	18.7	72.1	52.7	41.3	29.2	18.4	55
60	65.1	47.6	37.2	26.3	16.4	64.7	47.2	37.0	25.9	16.2	64.3	46.7	36.5	25.7	15.9	60
65	58.8	42.7	33.3	23.3	14.4	58.3	42.5	33.1	23.1	14.1	57.9	42.0	32.7	22.6	13.7	65
70	53.6	38.7	30.2	20.9	12.6	53.1	38.5	29.8	20.6	12.4	52.7	38.1	29.5	20.3	12.1	70
75	-	-	-	-	-	48.6	35.0	27.0	18.6	10.9	48.2	34.7	26.8	18.3	10.7	75
80	-	-	-	-	-	-	32.0	24.6	-	-	44.3	31.7	24.4	16.4	9.4	80
85	-	-	-	-	-	-	29.5	22.6	-	-	41.0	29.0	22.2	14.9	8.2	85
90	-	-	-	-	-	-	-	-	-	-	37.9	27.0	20.5	-	7.4	90
Parts of line	9	7	6	5	3	8	6	5	4	3	8	6	5	4	3	Parts of line

Unit:klb

H Load Chart

SCA1350A crawler crane - H configuration load chart 3/6

Main hook, Boom 52.5~249.3ft, without aux tip extension

Boom length (ft)	111.5					121.4					131.2					Boom length (ft)	
	Counterweight (klb) Radius (ft)	119.0+ 441	95.9+0	72.8+0	26.5+0	0+0	119.0+ 441	95.9+0	72.8+0	26.5+0	0+0	119.0+ 441	95.9+0	72.8+0	26.5+0		0+0
24	177.7	-	-	-	-	-	-	-	-	-	-	-	-	-	-	-	24
26	163.1	-	-	-	-	-	-	-	-	-	-	-	-	-	-	-	26
28	151.6	128.1	102.8	75.3	49.9	147.6	-	-	-	-	137.3	-	-	-	-	-	28
30	141.0	117.9	94.4	69.0	45.4	137.3	114.9	91.9	66.9	43.9	133.2	111.9	89.5	65.0	42.4	-	30
32	132.3	109.4	87.3	63.7	41.8	128.9	106.9	85.3	62.0	40.4	125.0	104.1	83.1	60.1	39.1	-	32
34	124.9	101.7	80.9	58.9	38.6	121.7	99.6	79.4	57.5	37.5	118.0	97.3	77.5	56.0	36.2	-	34
36	118.3	94.3	75.0	54.4	35.6	115.4	92.9	73.9	53.4	34.8	111.8	91.2	72.5	52.3	33.7	-	36
38	111.8	87.0	69.1	50.0	32.7	109.0	86.2	68.4	49.3	32.2	105.6	85.1	67.5	48.6	31.2	-	38
40	105.7	80.5	63.8	46.0	30.0	103.3	80.1	63.4	45.6	29.8	100.0	79.4	62.9	45.2	28.9	-	40
45	92.8	68.6	54.1	38.8	25.0	91.7	68.1	53.8	38.4	24.6	88.9	67.7	53.4	37.9	24.2	-	45
50	81.4	59.5	46.8	33.2	21.2	81.0	59.1	46.4	32.9	20.7	79.5	58.6	46.1	32.5	20.5	-	50
55	71.7	52.2	40.9	28.8	18.0	71.7	51.9	40.5	28.5	17.6	70.8	51.4	40.2	28.1	17.4	-	55
60	63.8	46.3	36.1	25.2	15.5	63.8	46.0	35.6	24.8	15.0	62.9	45.6	35.4	24.6	14.8	-	60
65	57.4	41.6	32.2	22.4	13.5	57.4	41.2	31.8	22.0	13.0	56.6	40.7	31.6	21.5	12.8	-	65
70	52.2	37.6	29.1	20.0	11.8	52.2	37.2	28.6	19.5	11.3	51.5	36.9	28.3	19.2	11.1	-	70
75	47.8	34.2	26.4	17.8	10.3	47.8	33.8	25.9	17.5	9.8	47.0	33.5	25.6	17.2	9.6	-	75
80	43.9	31.3	23.9	15.9	9.0	43.9	30.9	23.5	15.7	8.6	43.0	30.4	23.3	15.3	8.3	-	80
85	40.3	28.6	21.7	14.4	7.8	40.3	28.4	21.5	14.2	7.6	39.7	27.9	21.1	13.8	7.1	-	85
90	37.4	26.5	20.0	13.1	6.9	37.4	26.2	19.6	12.8	6.5	36.8	25.7	19.4	12.4	6.1	-	90
95	34.9	24.5	18.4	11.8	6.1	34.9	24.2	18.0	11.6	5.7	34.1	23.7	17.8	11.2	5.2	-	95
100	-	-	-	-	-	32.6	22.4	16.6	10.5	-	31.8	22.0	16.3	10.1	-	-	100
105	-	-	-	-	-	-	-	-	-	-	29.8	20.5	15.0	9.3	-	-	105
110	-	-	-	-	-	-	-	-	-	-	27.9	19.0	13.8	8.4	-	-	110
115	-	-	-	-	-	-	-	-	-	-	26.2	17.7	12.7	7.6	-	-	115
Parts of line	7	6	5	4	3	6	5	4	3	2	6	5	4	3	2	-	Parts of line

H Load Chart

SCA1350A crawler crane - H configuration load chart 4/6													
Main hook, Boom 52.5~249.3ft, without aux tip extension													
Boom length (ft)	141.1				150.9				160.8				Boom length (ft)
Counterweight (klb) Radius (ft)	119.0+ 441	95.9+0	72.8+0	26.5+0	119.0+ 441	95.9+0	72.8+0	26.5+0	119.0+ 441	95.9+0	72.8+0	26.5+0	Counterweight (klb) Radius (ft)
30	119.3	108.9	86.9	63.0	116.4	-	-	-	113.1	-	-	-	30
32	113.9	101.4	80.8	58.3	111.7	-	-	-	105.9	-	-	-	32
34	109.4	95.0	75.5	54.4	107.3	92.7	73.6	52.9	100.9	90.3	71.7	51.4	34
36	105.3	89.4	71.0	51.0	103.1	87.3	69.2	49.5	97.4	85.1	67.4	48.1	36
38	101.3	83.8	66.4	47.5	99.0	81.9	64.8	46.2	93.9	79.9	63.1	44.8	38
40	97.2	78.6	62.1	44.3	94.8	76.9	60.7	43.1	90.4	75.1	59.2	41.8	40
45	86.6	67.2	52.9	37.4	84.4	66.5	52.3	37.1	81.8	65.7	51.5	35.9	45
50	77.5	58.2	45.7	32.0	75.7	57.7	45.2	31.8	73.8	57.2	44.7	31.1	50
55	69.6	51.0	39.8	27.7	68.3	50.5	39.4	27.4	66.6	50.1	38.9	26.9	55
60	62.5	45.1	35.0	24.1	61.7	44.7	34.5	23.7	60.3	44.3	34.1	23.3	60
65	56.1	40.3	31.1	21.3	55.6	40.0	30.7	20.8	55.1	39.4	30.2	20.4	65
70	50.9	36.4	27.8	18.9	50.6	36.1	27.5	18.4	50.0	35.6	27.1	18.0	70
75	46.4	33.0	25.1	16.8	46.1	32.7	24.8	16.4	45.6	32.2	24.4	15.9	75
80	42.6	30.0	22.8	15.0	42.1	29.7	22.4	14.6	41.7	29.3	22.0	14.2	80
85	39.2	27.5	20.6	13.3	38.8	27.1	20.4	13.1	38.3	26.6	20.0	12.7	85
90	36.3	25.3	18.9	12.0	35.9	25.0	18.5	11.7	35.4	24.6	18.1	11.1	90
95	33.7	23.3	17.3	10.8	33.4	23.1	16.9	10.5	32.8	22.6	16.5	9.9	95
100	31.3	21.6	15.9	9.8	31.1	21.3	15.4	9.4	30.4	20.9	15.0	8.9	100
105	29.3	20.1	14.5	8.8	28.9	19.6	14.1	8.4	28.4	19.2	13.7	7.7	105
110	27.5	18.5	13.4	8.0	27.0	18.3	13.1	7.5	26.6	17.8	12.7	6.9	110
115	25.7	17.3	12.3	7.1	25.3	16.9	12.1	6.7	24.8	16.5	11.6	6.1	115
120	24.1	16.1	11.4	6.4	23.7	15.7	11.1	5.9	23.3	15.3	10.6	5.4	120
125	-	-	-	-	22.4	14.7	10.1	5.3	22.0	14.3	9.7	-	125
130	-	-	-	-	21.0	13.7	9.4	4.8	20.6	13.3	9.0	-	130
135	-	-	-	-	-	-	-	-	19.4	12.4	8.2	-	135
140	-	-	-	-	-	-	-	-	18.3	11.5	7.4	-	140
Parts of line	5	5	4	3	5	4	3	3	5	4	3	3	Parts of line

Unit:klb

H Load Chart

SCA1350A crawler crane - H configuration load chart 5/6

Main hook, Boom 52.5~249.3ft, without aux tip extension

Boom length (ft)	170.6			180.4			190.3			Boom length (ft)
Counterweight (klb)	119.0+44.1	95.9+0	72.8+0	119.0+44.1	95.9+0	72.8+0	119.0+44.1	95.9+0	72.8+0	Counterweight (klb)
Radius (ft)										Radius (ft)
34	98.9	88.2	69.8	96.9	-	-	86.8	-	-	34
36	96.1	83.1	65.7	94.2	-	-	84.1	-	-	36
38	93.4	78.0	61.5	91.4	-	-	81.4	-	-	38
40	90.2	73.4	57.7	88.3	71.8	56.4	79.1	70.1	54.9	40
45	80.1	64.3	50.1	78.3	62.7	49.0	75.2	61.4	47.6	45
50	72.1	56.5	43.9	70.3	55.6	43.1	68.6	54.3	41.9	50
55	65.1	49.7	38.5	63.5	49.2	37.9	62.0	48.2	37.0	55
60	59.0	43.9	33.7	57.7	43.4	33.2	56.2	43.0	32.8	60
65	53.8	39.2	29.8	52.6	38.7	29.5	51.3	38.3	29.1	65
70	49.4	35.2	26.7	48.3	34.7	26.3	47.0	34.3	25.9	70
75	45.2	31.8	23.9	44.4	31.4	23.6	43.3	30.9	23.1	75
80	41.3	28.9	21.5	40.8	28.5	21.3	40.0	28.0	20.8	80
85	37.9	26.4	19.5	37.5	25.9	19.1	37.0	25.5	18.6	85
90	35.0	24.2	17.7	34.6	23.7	17.4	34.1	23.3	16.9	90
95	32.5	22.2	16.1	32.0	21.8	15.8	31.6	21.3	15.3	95
100	30.2	20.4	14.8	29.7	20.0	14.3	29.3	19.6	13.7	100
105	28.0	18.7	13.4	27.5	18.5	13.0	27.1	18.1	12.3	105
110	26.1	17.4	12.3	25.7	17.0	11.8	25.3	16.6	11.3	110
115	24.5	16.2	11.2	24.1	15.7	10.8	23.6	15.3	10.2	115
120	23.0	15.0	10.3	22.6	14.5	9.8	22.1	14.1	9.2	120
125	21.5	13.8	9.4	21.1	13.4	9.0	20.6	12.9	8.3	125
130	20.2	12.8	8.6	19.7	12.5	8.1	19.3	12.1	7.5	130
135	19.0	11.9	7.9	18.6	11.6	7.4	18.2	11.1	6.8	135
140	17.8	11.1	7.2	17.6	10.7	6.8	17.1	10.3	6.1	140
145	16.8	10.3	6.5	16.4	10.0	6.1	16.0	9.6	5.4	145
150	15.8	9.6	5.9	15.6	9.2	5.6	15.1	8.7	4.7	150
155	-	-	-	14.6	8.5	5.0	14.2	8.0	-	155
160	-	-	-	-	-	-	13.3	7.5	-	160
Parts of line	4	4	3	4	3	3	4	3	3	Parts of line

H Load Chart

SCA1350A crawler crane - H configuration load chart 6/6										
Main hook, Boom 52.5~249.3ft, without aux tip extension										
Boom length (ft)	200.1		210		219.8		229.7	239.5	249.3	Boom length (ft)
Counterweight (klb)	119.0+441	95.9+0	119.0+441	95.9+0	119.0+441	95.9+0	119.0+441	119.0+441	119.0+441	Counterweight (klb)
Radius (ft)										Radius (ft)
40	77.4	68.4	72.0	-	66.0	-	60.4	52.9	49.7	40
45	73.7	60.0	69.1	-	63.5	-	58.9	52.7	49.1	45
50	67.1	53.1	64.5	51.8	60.3	50.5	56.9	51.9	48.4	50
55	60.5	47.2	59.1	46.1	56.5	45.0	54.3	50.8	47.5	55
60	54.9	42.2	53.6	41.1	52.2	40.2	50.9	49.1	46.1	60
65	50.0	37.8	48.9	37.1	47.5	36.0	46.4	45.2	43.9	65
70	45.8	34.0	44.7	33.5	43.6	32.7	42.5	41.5	40.4	70
75	42.2	30.6	41.1	30.3	40.1	29.5	39.0	38.1	37.0	75
80	39.0	27.6	37.9	27.3	37.0	26.5	35.9	35.0	33.9	80
85	36.1	25.1	35.0	24.6	34.1	24.0	33.2	32.1	31.2	85
90	33.6	22.9	32.5	22.6	31.6	21.8	30.7	29.8	28.9	90
95	31.1	20.9	30.2	20.7	29.3	19.8	28.4	27.6	26.7	95
100	28.9	19.1	28.1	18.9	27.2	18.0	26.3	25.6	24.8	100
105	26.9	17.6	26.2	17.2	25.3	16.5	24.5	23.8	22.9	105
110	25.0	16.3	24.5	15.8	23.7	15.0	22.8	22.1	21.2	110
115	23.3	14.9	22.9	14.5	22.1	13.7	21.2	20.6	19.7	115
120	21.7	13.7	21.3	13.3	20.6	12.6	19.8	19.1	18.2	120
125	20.2	12.7	20.0	12.3	19.1	11.4	18.4	17.8	16.9	125
130	19.0	11.7	18.6	11.3	17.9	10.4	17.3	16.6	15.7	130
135	17.8	10.8	17.4	10.3	16.7	9.5	16.1	15.4	14.5	135
140	16.7	10.0	16.3	9.3	15.6	8.7	15.0	14.3	13.4	140
145	15.7	9.2	15.3	8.5	14.6	7.8	14.0	13.3	12.5	145
150	14.7	8.5	14.3	7.8	13.6	7.2	13.0	12.3	11.6	150
155	13.9	7.8	13.4	7.2	12.8	6.5	12.1	11.4	10.8	155
160	13.0	7.2	12.6	6.5	11.9	5.8	11.3	10.6	9.9	160
165	12.2	-	11.8	-	11.1	-	10.4	9.8	9.1	165
170	11.5	-	11.1	-	10.4	-	9.8	9.1	8.5	170
175	10.7	-	10.4	-	9.8	-	9.1	8.4	7.8	175
180	-	-	9.8	-	9.1	-	8.4	7.8	7.1	180
185	-	-	-	-	8.5	-	7.8	7.1	6.3	185
190	-	-	-	-	8.0	-	7.3	6.6	5.3	190
195	-	-	-	-	-	-	6.6	6.0	-	195
200	-	-	-	-	-	-	6.1	-	-	200
Parts of line	3	3	3	3	3	3	3	2	2	Parts of line

Hh Configuration

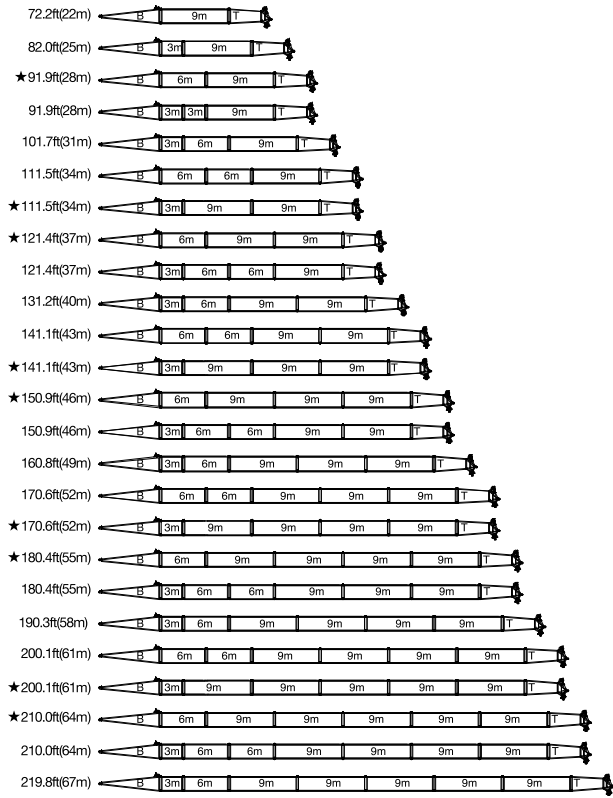

Note: The boom combinations with "★" are recommended configurations.

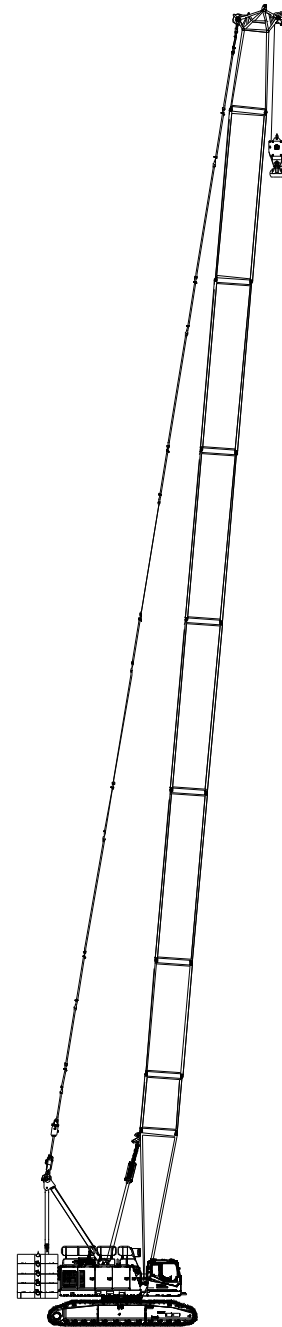
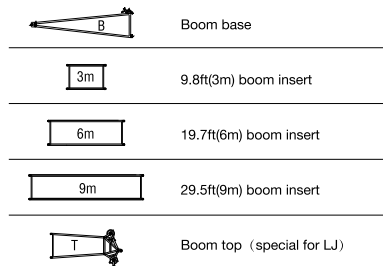

Hh Configuration
72.2ft~219.8ft(22m~67m)

Hh Working Radius

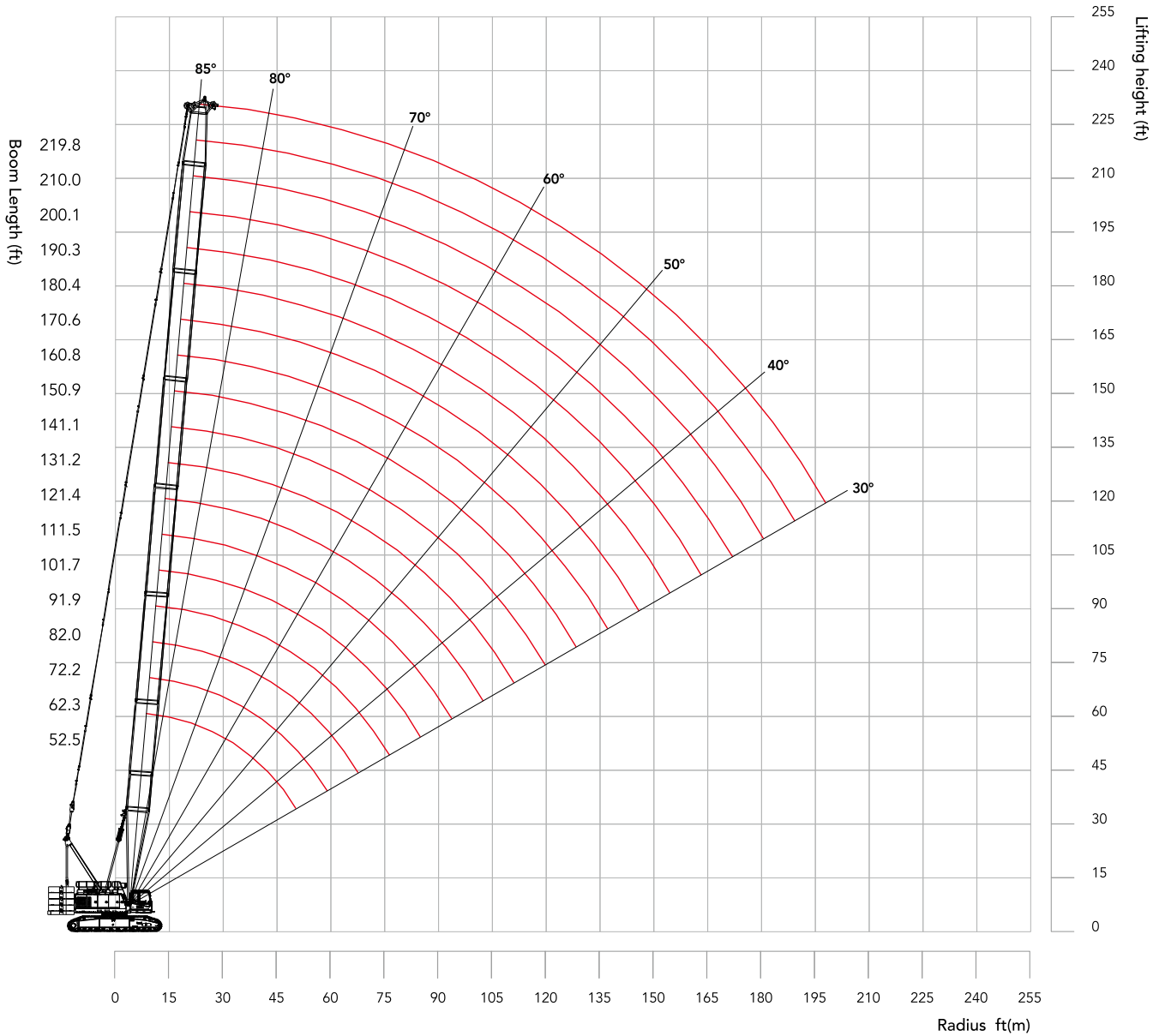



Unit:klb

Hh Load Chart

SCA1350A crawler crane - Hh configuration load chart																		
Main hook, Boom 72.2~219.8ft, Rear counterweight 119 klbs, Carbody counterweight 44.1klbs																		
Boom length (ft) Radius (ft)	72.2	82	91.9	101.7	111.5	121.4	131.2	141.1	150.9	160.8	170.6	180.4	190.3	200.1	210	219.8	Boom length (ft) Radius (ft)	
24	158.3	157.7	157.1	-	-	-	-	-	-	-	-	-	-	-	-	-	24	
26	157.3	156.5	155.6	-	-	-	-	-	-	-	-	-	-	-	-	-	26	
28	155.9	154.8	153.9	151.0	148.2	145.9	137.3	127.8	-	-	-	-	-	-	-	-	28	
30	152.4	151.1	150.2	145.5	141.0	137.3	133.2	119.3	116.4	113.1	105.6	104.0	92.9	-	-	-	30	
32	142.5	141.1	140.1	136.4	132.3	128.9	125.0	113.9	111.7	105.9	102.0	100.1	89.7	-	-	-	32	
34	133.8	132.6	131.6	128.7	124.9	121.7	118.0	109.4	107.3	100.9	98.9	96.9	86.8	83.1	74.8	67.8	34	
36	126.1	125.0	124.1	122.0	118.3	115.4	111.8	105.3	103.1	97.4	96.1	94.2	84.1	81.1	73.9	67.3	36	
38	118.4	117.4	116.6	115.3	111.8	109.0	105.6	101.3	99.0	93.9	93.4	91.4	81.4	79.2	73.0	66.7	38	
40	111.1	110.3	109.6	108.8	105.7	103.3	100.0	97.2	94.8	90.4	90.2	88.2	79.0	77.0	71.9	66.0	40	
45	95.5	94.8	94.3	93.8	92.8	91.7	88.9	86.6	84.4	81.8	80.1	77.6	73.9	70.6	68.2	63.5	45	
50	83.4	82.8	82.3	81.9	81.4	81.0	79.5	77.5	75.7	73.8	72.1	69.2	66.5	63.6	61.6	58.4	50	
55	73.6	73.0	72.6	72.1	71.7	71.7	70.8	69.6	68.3	66.6	65.1	62.0	59.7	57.2	55.1	52.9	55	
60	65.6	65.1	64.7	64.3	63.8	63.8	62.9	62.5	61.7	60.3	59.0	55.8	53.9	51.8	49.6	47.9	60	
65	59.2	58.8	58.3	57.9	57.4	57.4	56.6	56.1	55.6	55.1	53.8	51.1	48.9	46.9	45.1	43.5	65	
70	-	53.6	53.1	52.7	52.2	52.2	51.5	50.9	50.6	50.0	49.4	46.8	44.9	42.9	41.4	39.7	70	
75	-	-	48.6	48.2	47.8	47.8	47.0	46.4	46.1	45.6	45.2	42.9	41.2	39.4	38.1	36.3	75	
80	-	-	-	44.3	43.9	43.9	43.0	42.6	42.1	41.7	41.3	39.4	37.9	36.4	35.0	33.3	80	
85	-	-	-	41.0	40.3	40.3	39.7	39.2	38.8	38.3	37.9	36.5	35.0	33.7	32.1	30.8	85	
90	-	-	-	37.9	37.4	37.4	36.8	36.3	35.9	35.4	35.0	33.8	32.5	31.1	29.6	28.4	90	
95	-	-	-	-	34.8	34.9	34.1	33.7	33.4	32.8	32.5	31.5	30.2	28.8	27.5	26.3	95	
100	-	-	-	-	-	32.5	31.8	31.3	31.1	30.4	30.2	29.3	28.0	26.7	25.6	24.4	100	
105	-	-	-	-	-	-	29.8	29.3	28.9	28.4	28.0	27.1	26.0	24.7	23.8	22.7	105	
110	-	-	-	-	-	-	27.6	27.5	27.0	26.6	26.1	25.1	24.2	23.2	22.1	21.0	110	
115	-	-	-	-	-	-	25.0	25.4	25.3	24.8	24.3	23.4	22.4	21.7	20.6	19.5	115	
120	-	-	-	-	-	-	-	23.2	23.4	23.2	22.4	21.8	20.9	20.1	19.0	18.0	120	
125	-	-	-	-	-	-	-	-	21.3	21.5	20.6	20.0	19.5	18.6	17.5	16.7	125	
130	-	-	-	-	-	-	-	-	19.4	19.6	19.1	18.6	18.0	17.1	16.2	15.5	130	
135	-	-	-	-	-	-	-	-	-	18.0	17.5	17.3	16.7	16.0	15.0	14.4	135	
140	-	-	-	-	-	-	-	-	-	16.4	15.9	15.9	15.5	14.8	14.0	13.4	140	
145	-	-	-	-	-	-	-	-	-	-	14.6	14.6	14.2	13.5	13.1	12.2	145	
150	-	-	-	-	-	-	-	-	-	-	13.2	13.2	13.0	12.3	11.9	11.2	150	
155	-	-	-	-	-	-	-	-	-	-	-	11.9	11.7	11.4	10.9	10.2	155	
160	-	-	-	-	-	-	-	-	-	-	-	-	10.5	10.4	9.9	9.2	160	
165	-	-	-	-	-	-	-	-	-	-	-	-	-	9.2	9.0	8.2	165	
170	-	-	-	-	-	-	-	-	-	-	-	-	-	-	8.1	7.8	170	
175	-	-	-	-	-	-	-	-	-	-	-	-	-	-	7.2	7.0	175	
180	-	-	-	-	-	-	-	-	-	-	-	-	-	-	-	6.1	5.9	180
Parts of line	6	6	6	6	6	6	6	6	6	5	5	5	4	4	4	3	3	Parts of line

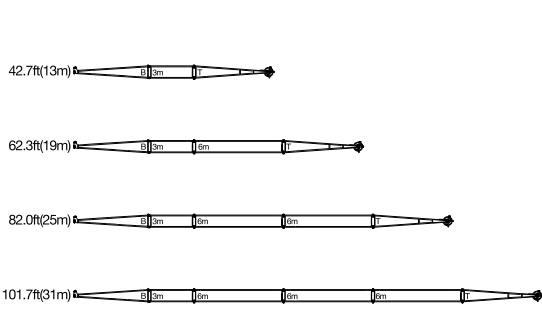
FJ Configuration

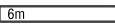
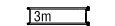

	16.4ft(5m)	Jib base
	16.4ft(5m)	Jib top
	19.7ft(6m)	Jib insert
	9.8 ft(3m)	Jib insert

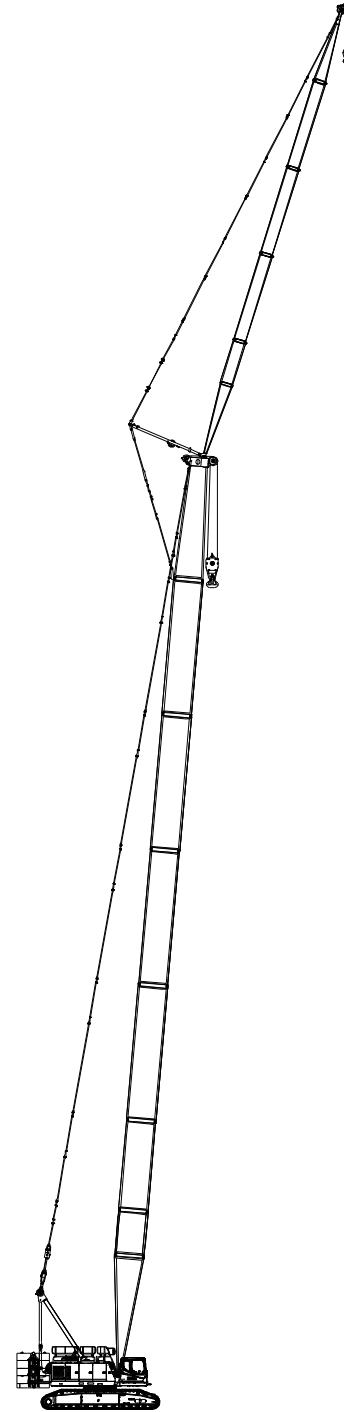

FJ Configuration
 (72.2ft~200.1ft)+(42.7ft~101.7ft)
 (22m~61m)+(13m~31m)

FJ Working Radius

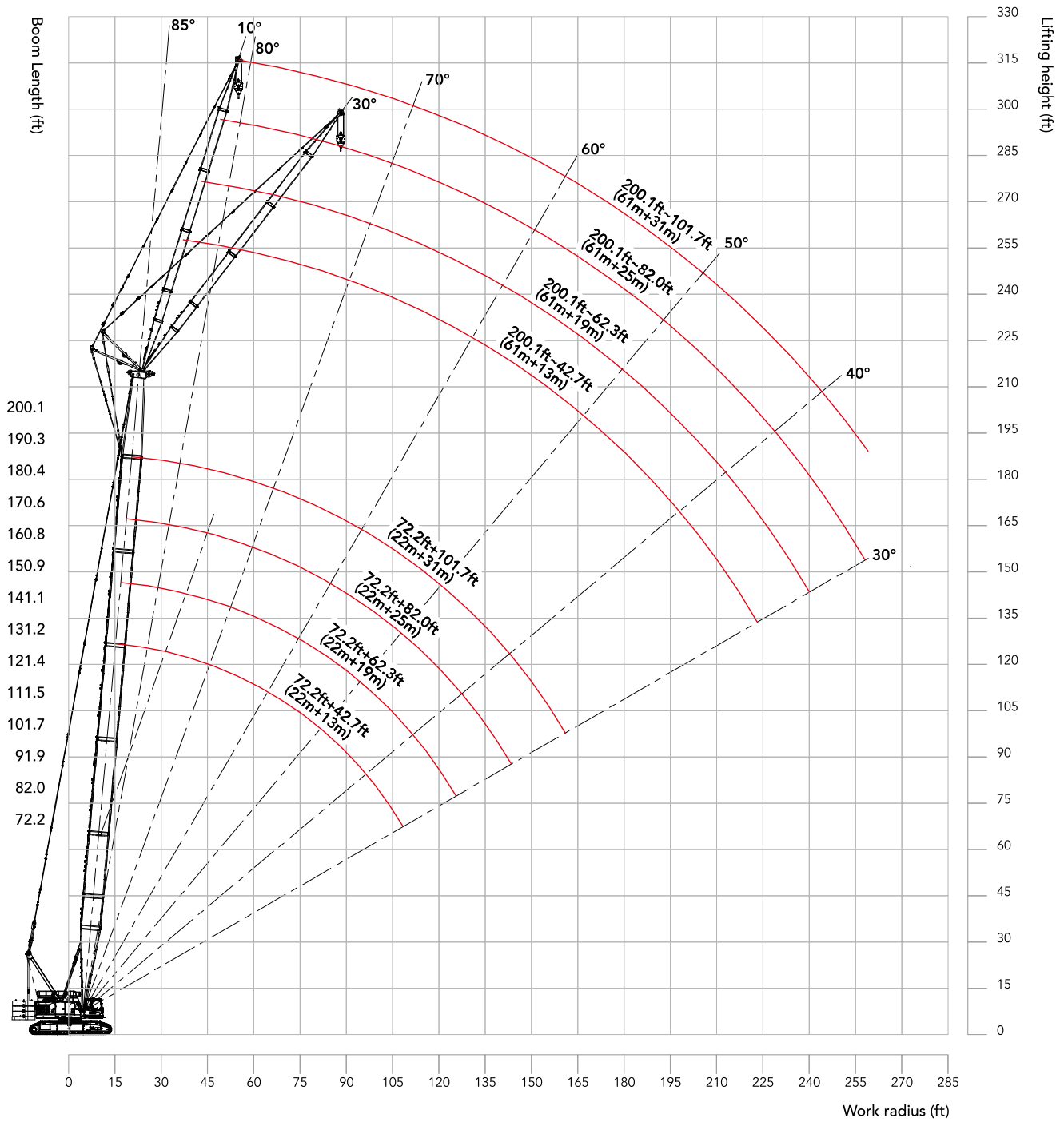

FJ Load Chart

Note:

1. The rated load in the load chart is calculated complying with ASME B30.5.
2. The working radius is the horizontal distance from the load center to the swing center.
3. The actual lifting capacity must subtract the weight of hooks and other riggings from the rated capacity in the load chart.
4. The load value is calculated when the object is hung freely, without considering the influence of wind on the load, ground conditions and slope, operation speed and the influence of any other negative factors over safe operation. Therefore, the operator bears the responsibility of making a judgement and decreasing the load and lowering speed.
5. All ratings are calculated when the machine is parking on firm and level ground with less than 1% gradient.
6. When the jib length is 42.7ft (13m), 1 part of line shall not be permitted.
7. See the Operation Manual for the complete load charts of FJ, FJm and FJa configurations.

SCA1350A crawler crane - FJ configuration load chart 1/4															
Aux. hook, Boom 72.2~200.1ft, Rear counterweight 119klbs, Carbody counterweight 44.1klbs, Jib 42.7ft, Boom to jib angle 10°, without main hook															
Fixed jib length Radius (ft)	72.2	82	91.9	101.7	111.5	121.4	131.2	141.1	150.9	160.8	170.6	180.4	190.3	200.1	Fixed jib length Radius (ft)
30	59.5	59.5	-	-	-	-	-	-	-	-	-	-	-	-	30
32	59.5	59.5	-	-	-	-	-	-	-	-	-	-	-	-	32
34	59.5	59.3	59.5	59.1	59.1	-	-	-	-	-	-	-	-	-	34
36	59.4	59.0	59.3	59.1	59.1	-	-	-	-	-	-	-	-	-	36
38	59.4	58.7	59.2	59.1	59.1	-	-	-	-	-	-	-	-	-	38
40	59.2	58.3	58.9	59.0	59.0	58.4	56.9	55.3	-	-	-	-	-	-	40
45	58.0	57.1	57.8	58.1	58.5	58.4	56.9	55.3	-	-	-	-	-	-	45
50	56.9	55.7	56.5	56.9	57.5	57.7	56.8	55.5	53.8	52.0	50.5	48.5	-	-	50
55	56.0	54.5	55.2	55.4	56.1	56.6	56.2	55.0	53.5	51.8	50.0	47.9	46.7	44.9	55
60	55.1	53.5	53.8	53.6	54.5	54.9	54.9	53.3	52.4	50.7	48.7	46.6	45.9	44.2	60
65	53.7	52.0	51.6	51.6	52.1	52.5	51.4	49.8	48.5	47.2	46.0	44.6	43.5	42.3	65
70	51.5	50.0	49.6	49.3	49.5	49.3	47.8	46.3	45.1	43.8	42.7	41.5	40.4	39.3	70
75	48.4	47.5	47.0	46.6	46.4	46.0	44.6	43.1	42.0	40.7	39.6	38.6	37.5	36.4	75
80	44.8	44.3	43.9	43.5	43.0	42.8	41.6	40.4	39.3	38.0	36.9	36.0	34.9	33.8	80
85	41.4	41.0	40.5	40.1	39.7	39.6	39.0	37.8	36.7	35.6	34.5	33.6	32.5	31.7	85
90	38.5	38.1	37.7	37.4	36.9	36.8	36.1	35.5	34.5	33.4	32.5	31.5	30.5	29.6	90
95	36.0	35.6	35.1	34.8	34.3	34.2	33.6	33.1	32.5	31.7	30.6	29.6	28.7	27.8	95
100	33.8	33.3	32.9	32.4	32.0	31.9	31.3	30.9	30.4	30.0	28.9	27.9	27.0	26.1	100
105	-	31.1	30.9	30.4	30.0	29.8	29.1	28.9	28.4	28.0	27.5	26.2	25.4	24.5	105
110	-	29.4	29.0	28.6	28.1	28.1	27.4	27.0	26.6	26.1	25.7	25.2	24.5	23.1	110
115	-	-	27.3	27.0	26.5	26.4	25.7	25.3	24.8	24.5	24.1	23.7	23.2	22.0	115
120	-	-	25.7	25.4	25.0	24.8	24.2	23.7	23.3	23.0	22.6	22.2	21.8	20.9	120
125	-	-	-	23.9	23.5	23.5	22.8	22.4	22.0	21.5	21.1	20.9	20.4	19.5	125
130	-	-	-	22.8	22.3	22.2	21.5	21.0	20.6	20.3	19.9	19.5	19.1	18.4	130
135	-	-	-	-	21.2	20.9	20.3	19.8	19.5	19.2	18.7	18.3	17.8	17.3	135
140	-	-	-	-	-	19.8	19.2	18.7	18.4	18.1	17.6	17.2	16.7	16.3	140
145	-	-	-	-	-	-	18.2	17.7	17.3	17.1	16.6	16.2	15.7	15.3	145
150	-	-	-	-	-	-	17.3	16.9	16.5	16.1	15.6	15.4	14.7	14.3	150
155	-	-	-	-	-	-	16.4	15.9	15.6	15.2	14.7	14.4	13.9	13.4	155
160	-	-	-	-	-	-	-	15.1	14.8	14.3	13.9	13.5	13.0	12.6	160
165	-	-	-	-	-	-	-	-	14.0	13.5	13.1	12.6	12.2	11.7	165
170	-	-	-	-	-	-	-	-	13.3	12.7	12.2	11.8	11.3	10.9	170
175	-	-	-	-	-	-	-	-	-	12.0	11.5	11.1	10.6	10.2	175
180	-	-	-	-	-	-	-	-	-	11.3	10.9	10.4	10.0	9.5	180
185	-	-	-	-	-	-	-	-	-	-	10.2	9.8	9.3	8.9	185
190	-	-	-	-	-	-	-	-	-	-	9.7	9.3	8.6	8.2	190
195	-	-	-	-	-	-	-	-	-	-	-	8.6	8.1	7.7	195
200	-	-	-	-	-	-	-	-	-	-	-	-	7.7	7.3	200
205	-	-	-	-	-	-	-	-	-	-	-	-	-	7.3	205
210	-	-	-	-	-	-	-	-	-	-	-	-	-	6.2	210
215	-	-	-	-	-	-	-	-	-	-	-	-	-	5.7	215
Parts of line	3	3	3	3	3	3	3	3	3	2	2	2	2	2	Parts of line

Unit:klb

FJ Load Chart

SCA1350A crawler crane - FJ configuration load chart 2/4

Aux. hook, Boom 72.2~200.1ft, Rear counterweight 119klbs, Carbody counterweight 44.1klbs,
Jib 42.7ft, Boom to jib angle 10°, without main hook

Fixed jib length (ft) Radius (ft)	72.2	82	91.9	101.7	111.5	121.4	131.2	141.1	150.9	160.8	170.6	180.4	190.3	200.1	Fixed jib length (ft) Radius (ft)
55	15.9	15.9	-	-	-	-	-	-	-	-	-	-	-	-	55
60	15.5	15.5	15.5	15.5	15.4	-	-	-	-	-	-	-	-	-	60
65	15.0	15.0	15.2	15.2	15.0	-	-	-	-	-	-	-	-	-	65
70	14.6	14.6	14.7	14.8	14.7	14.7	14.7	14.6	-	-	-	-	-	-	70
75	14.2	14.2	14.3	14.4	14.4	14.4	14.4	14.3	14.3	14.1	14.0	13.9	-	-	75
80	13.8	13.8	14.0	14.0	14.0	14.0	14.0	14.0	14.0	13.9	13.8	13.7	13.5	13.2	80
85	13.4	13.4	13.6	13.6	13.6	13.8	13.8	13.6	13.6	13.6	13.7	13.4	13.3	13.1	85
90	13.0	13.0	13.2	13.3	13.3	13.4	13.4	13.3	13.3	13.3	13.4	13.2	13.0	12.8	90
95	12.7	12.7	12.9	13.0	13.0	13.1	13.1	13.1	13.1	13.1	13.1	12.9	12.7	12.7	95
100	12.4	12.5	12.6	12.7	12.7	12.8	12.8	12.8	12.8	12.8	12.8	12.7	12.5	12.5	100
105	12.1	12.2	12.2	12.4	12.4	12.6	12.6	12.6	12.6	12.6	12.6	12.4	12.4	12.2	105
110	11.8	11.8	12.0	12.1	12.1	12.2	12.3	12.3	12.3	12.3	12.3	12.3	12.1	12.1	110
115	11.4	11.5	11.7	11.9	11.9	11.9	12.0	12.0	12.0	12.0	12.0	12.0	12.0	11.9	115
120	11.1	11.3	11.4	11.6	11.6	11.6	11.8	11.8	11.8	11.8	11.8	11.8	11.8	11.6	120
125	10.7	11.0	11.2	11.4	11.4	11.4	11.5	11.5	11.5	11.5	11.5	11.5	11.5	11.4	125
130	10.4	10.8	10.9	11.1	11.1	11.2	11.3	11.3	11.3	11.3	11.3	11.4	11.3	11.2	130
135	10.2	10.4	10.7	10.8	10.8	11.0	11.0	11.1	11.1	11.1	11.0	11.2	11.1	11.1	135
140	9.8	10.1	10.4	10.6	10.6	10.8	10.8	10.9	10.9	11.0	10.7	11.0	11.0	10.9	140
145	9.5	10.0	10.2	10.3	10.5	10.5	10.7	10.7	10.7	10.8	10.6	10.8	10.8	10.7	145
150	9.2	9.7	10.0	10.2	10.2	10.4	10.4	10.5	10.5	10.6	10.5	10.6	10.6	10.5	150
155	9.0	9.4	9.8	10.0	10.1	10.1	10.3	10.3	10.4	10.4	10.4	10.4	10.4	10.4	155
160	-	9.0	9.5	9.8	9.9	10.0	10.1	10.1	10.2	10.2	10.3	10.3	10.3	10.3	160
165	-	8.8	9.3	9.6	9.7	9.8	10.0	10.0	10.0	10.0	10.1	10.1	10.1	10.1	165
170	-	8.7	9.0	9.2	9.5	9.7	9.7	9.7	9.9	9.9	9.9	9.9	9.9	9.9	170
175	-	-	8.8	9.1	9.4	9.6	9.6	9.6	9.7	9.7	9.6	9.6	9.6	9.6	175
180	-	-	-	8.8	9.2	9.4	9.4	9.4	9.6	9.6	9.4	9.4	9.4	9.4	180
185	-	-	-	-	9.0	9.3	9.3	9.3	9.5	9.4	9.2	9.2	9.2	9.2	185
190	-	-	-	-	8.8	9.0	9.2	9.1	9.3	9.3	9.0	9.0	9.0	8.8	190
195	-	-	-	-	8.6	8.8	9.0	8.8	8.9	9.1	8.9	8.9	8.9	8.5	195
200	-	-	-	-	-	-	8.8	8.5	8.6	8.8	8.7	8.7	8.6	8.1	200
205	-	-	-	-	-	-	8.4	8.3	8.3	8.5	8.5	8.5	8.2	7.6	205
210	-	-	-	-	-	-	-	-	7.9	8.2	8.2	8.2	7.7	7.1	210
215	-	-	-	-	-	-	-	-	7.4	7.8	7.8	7.6	7.2	6.7	215
220	-	-	-	-	-	-	-	-	7.0	7.5	7.5	7.1	6.7	6.3	220
225	-	-	-	-	-	-	-	-	6.7	7.1	7.1	6.7	6.2	5.8	225
230	-	-	-	-	-	-	-	-	-	6.8	6.8	6.4	5.7	5.3	230
235	-	-	-	-	-	-	-	-	-	6.5	6.3	5.8	5.4	4.9	235
240	-	-	-	-	-	-	-	-	-	-	-	5.5	5.0	-	240
245	-	-	-	-	-	-	-	-	-	-	-	5.1	4.8	-	245
250	-	-	-	-	-	-	-	-	-	-	-	4.8	-	-	250
255	-	-	-	-	-	-	-	-	-	-	-	4.7	-	-	255
Parts of line	1	1	1	1	1	1	1	1	1	1	1	1	1	1	Parts of line

FJ Load Chart

SCA1350A crawler crane - FJ configuration load chart 3/4															
Aux. hook, Boom 72.2~200.1ft, Rear counterweight 119klbs, Carbody counterweight 44.1klbs, Jib 42.7ft, Boom to jib angle 10°, without main hook															
Fixed jib length Radius (ft)	72.2	82	91.9	101.7	111.5	121.4	131.2	141.1	150.9	160.8	170.6	180.4	190.3	200.1	Fixed jib length Radius (ft)
40	51.6	50.8	-	-	-	-	-	-	-	-	-	-	-	-	40
45	50.3	49.4	-	-	-	-	-	-	-	-	-	-	-	-	45
50	48.8	48.1	47.8	47.5	47.2	-	-	-	-	-	-	-	-	-	50
55	47.0	46.3	46.1	46.0	45.7	45.5	45.3	45.1	-	-	-	-	-	-	55
60	44.9	44.3	44.0	44.0	43.7	43.5	43.3	43.1	42.9	42.6	42.4	42.2	-	-	60
65	43.4	42.7	42.5	42.3	41.9	41.7	41.5	41.2	41.0	40.8	40.6	40.4	-	-	65
70	41.9	41.2	40.7	40.3	40.0	39.7	39.5	39.2	39.0	38.8	38.6	38.4	38.1	37.3	70
75	40.5	39.8	39.1	38.7	38.4	38.0	37.8	37.6	37.4	37.2	36.8	36.6	36.3	35.7	75
80	39.2	38.5	37.8	37.4	36.9	36.7	36.4	36.2	36.0	35.8	35.3	35.1	34.6	34.1	80
85	38.0	37.1	36.5	36.0	35.6	35.4	34.9	34.7	34.5	34.3	33.8	33.6	32.7	31.9	85
90	36.8	35.9	35.3	34.8	34.5	34.3	33.9	33.7	33.4	33.2	32.5	31.6	30.7	29.8	90
95	35.5	34.7	34.0	33.7	33.4	33.1	32.7	32.4	32.2	31.7	30.8	29.8	28.9	28.0	95
100	34.0	33.0	32.6	32.4	32.1	31.8	31.3	31.0	30.8	29.9	29.1	28.2	27.3	26.4	100
105	-	30.9	31.3	30.9	30.6	30.4	30.0	29.5	29.3	28.2	27.6	26.7	25.8	24.9	105
110	-	29.3	29.3	29.0	28.6	28.6	28.1	27.7	27.5	26.9	26.0	25.2	24.4	23.6	110
115	-	27.8	27.6	27.3	27.0	26.8	26.4	26.0	25.7	25.3	24.8	24.1	23.1	22.3	115
120	-	-	26.1	25.7	25.4	25.3	24.8	24.3	24.1	23.7	23.5	23.0	22.0	21.2	120
125	-	-	-	24.2	23.9	23.9	23.3	22.8	22.6	22.2	22.0	21.5	21.3	20.0	125
130	-	-	-	22.8	22.6	22.6	21.9	21.7	21.3	20.8	20.6	20.3	19.9	19.3	130
135	-	-	-	-	21.4	21.4	20.7	20.4	20.1	19.6	19.4	19.0	18.7	18.3	135
140	-	-	-	-	20.2	20.2	19.6	19.2	19.0	18.5	18.2	17.8	17.6	17.2	140
145	-	-	-	-	-	19.0	18.6	18.2	17.9	17.5	17.1	16.8	16.4	16.2	145
150	-	-	-	-	-	18.0	17.6	17.2	16.9	16.5	16.2	15.8	15.4	15.2	150
155	-	-	-	-	-	-	16.6	16.3	15.9	15.6	15.3	15.0	14.5	14.2	155
160	-	-	-	-	-	-	-	15.4	15.0	14.8	14.3	14.0	13.7	13.2	160
165	-	-	-	-	-	-	-	-	14.2	13.9	13.5	13.1	12.8	12.4	165
170	-	-	-	-	-	-	-	-	13.5	13.1	12.7	12.4	12.0	11.6	170
175	-	-	-	-	-	-	-	-	12.7	12.3	12.0	11.6	11.2	10.7	175
180	-	-	-	-	-	-	-	-	-	11.5	11.2	10.9	10.4	10.0	180
185	-	-	-	-	-	-	-	-	-	-	10.4	10.2	9.7	9.3	185
190	-	-	-	-	-	-	-	-	-	-	9.7	9.5	9.1	8.6	190
195	-	-	-	-	-	-	-	-	-	-	-	8.8	8.4	8.1	195
200	-	-	-	-	-	-	-	-	-	-	-	8.3	7.8	7.5	200
205	-	-	-	-	-	-	-	-	-	-	-	-	7.3	6.9	205
210	-	-	-	-	-	-	-	-	-	-	-	-	-	6.4	210
215	-	-	-	-	-	-	-	-	-	-	-	-	-	5.9	215
Parts of line	2	2	2	2	2	2	2	2	2	2	2	2	2	2	Parts of line

Unit:klb

FJ Load Chart

SCA1350A crawler crane - FJ configuration load chart 4/4

Aux. hook, Boom 72.2~200.1ft, Rear counterweight 119klbs, Carbody counterweight 44.1klbs,
Jib 42.7ft, Boom to jib angle 10°, without main hook

Fixed jib length (ft) Radius (ft)	72.2	82	91.9	101.7	111.5	121.4	131.2	141.1	150.9	160.8	170.6	180.4	190.3	200.1	Fixed jib length (ft) Radius (ft)
80	12.0	12.1	-	-	-	-	-	-	-	-	-	-	-	-	80
85	11.6	11.8	-	-	-	-	-	-	-	-	-	-	-	-	85
90	11.2	11.4	11.4	11.4	11.3	-	-	-	-	-	-	-	-	-	90
95	10.9	11.1	11.0	11.1	11.0	11.4	11.3	11.3	-	-	-	-	-	-	95
100	10.6	10.8	10.7	10.8	10.8	11.2	11.0	11.0	11.0	11.0	11.2	11.2	-	-	100
105	10.2	10.4	10.4	10.6	10.6	10.9	10.8	10.8	10.8	10.8	11.0	11.0	11.1	11.0	105
110	10.0	10.1	10.2	10.3	10.2	10.7	10.5	10.5	10.6	10.6	10.7	10.8	10.9	10.9	110
115	9.7	9.9	9.9	10.1	10.0	10.4	10.3	10.3	10.3	10.4	10.5	10.6	10.6	10.7	115
120	9.5	9.7	9.7	9.9	9.8	10.2	10.1	10.1	10.1	10.2	10.2	10.4	10.4	10.5	120
125	9.4	9.5	9.5	9.7	9.5	9.9	9.9	10.0	9.8	10.0	9.9	10.2	10.3	10.4	125
130	9.1	9.3	9.3	9.5	9.3	9.6	9.7	9.7	9.7	9.9	9.9	10.0	10.1	10.2	130
135	9.0	9.1	9.2	9.2	9.1	9.4	9.5	9.6	9.6	9.7	9.8	9.9	9.9	10.0	135
140	8.9	9.0	9.0	9.0	9.0	9.2	9.4	9.4	9.5	9.5	9.6	9.7	9.8	9.8	140
145	8.8	8.9	8.8	8.8	8.8	9.0	9.3	9.3	9.3	9.4	9.5	9.5	9.7	9.7	145
150	8.6	8.8	8.6	8.8	8.8	8.8	9.2	9.1	9.1	9.2	9.4	9.4	9.5	9.5	150
155	8.4	8.6	8.5	8.7	8.7	8.7	8.9	8.9	8.9	9.1	9.3	9.3	9.4	9.3	155
160	8.4	8.5	8.4	8.5	8.6	8.6	8.7	8.8	8.8	9.0	9.1	9.1	9.2	9.2	160
165	-	8.4	8.3	8.4	8.6	8.6	8.6	8.7	8.7	8.9	9.0	9.0	9.0	9.0	165
170	-	8.2	8.2	8.3	8.4	8.4	8.4	8.7	8.6	8.7	8.9	8.9	8.8	8.8	170
175	-	8.0	8.0	8.2	8.3	8.2	8.2	8.6	8.5	8.6	8.7	8.8	8.7	8.7	175
180	-	-	7.8	8.1	8.2	8.2	8.2	8.5	8.3	8.5	8.5	8.7	8.5	8.5	180
185	-	-	-	7.9	8.1	8.1	8.1	8.3	8.3	8.4	8.3	8.5	8.3	8.3	185
190	-	-	-	7.7	7.9	7.9	7.9	8.2	8.3	8.3	8.2	8.3	8.2	8.2	190
195	-	-	-	-	7.8	7.8	7.8	8.0	8.1	8.0	8.0	8.0	8.0	8.0	195
200	-	-	-	-	-	7.6	7.6	7.8	8.0	7.8	7.8	7.8	7.8	7.7	200
205	-	-	-	-	-	7.4	7.4	7.5	7.9	7.7	7.7	7.7	7.7	7.4	205
210	-	-	-	-	-	-	7.3	7.3	7.7	7.5	7.5	7.5	7.5	7.1	210
215	-	-	-	-	-	-	7.1	7.1	7.5	7.3	7.3	7.3	7.3	6.9	215
220	-	-	-	-	-	-	-	6.9	7.4	7.2	7.2	7.0	7.2	6.7	220
225	-	-	-	-	-	-	-	-	7.2	7.0	7.0	6.7	6.9	6.5	225
230	-	-	-	-	-	-	-	-	7.0	6.8	6.8	6.4	6.6	6.1	230
235	-	-	-	-	-	-	-	-	6.9	6.7	6.5	6.0	6.3	5.8	235
240	-	-	-	-	-	-	-	-	-	6.5	6.1	5.7	5.8	5.5	240
245	-	-	-	-	-	-	-	-	-	-	5.8	5.4	5.3	5.1	245
Parts of line	1	1	1	1	1	1	1	1	1	1	1	1	1	1	Parts of line

LJ Configuration

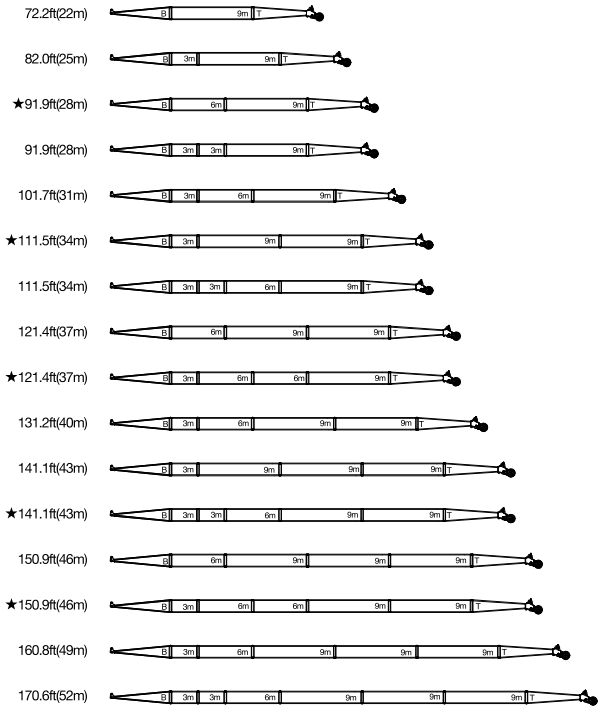

Note: The boom combinations with "★" are recommended configurations.

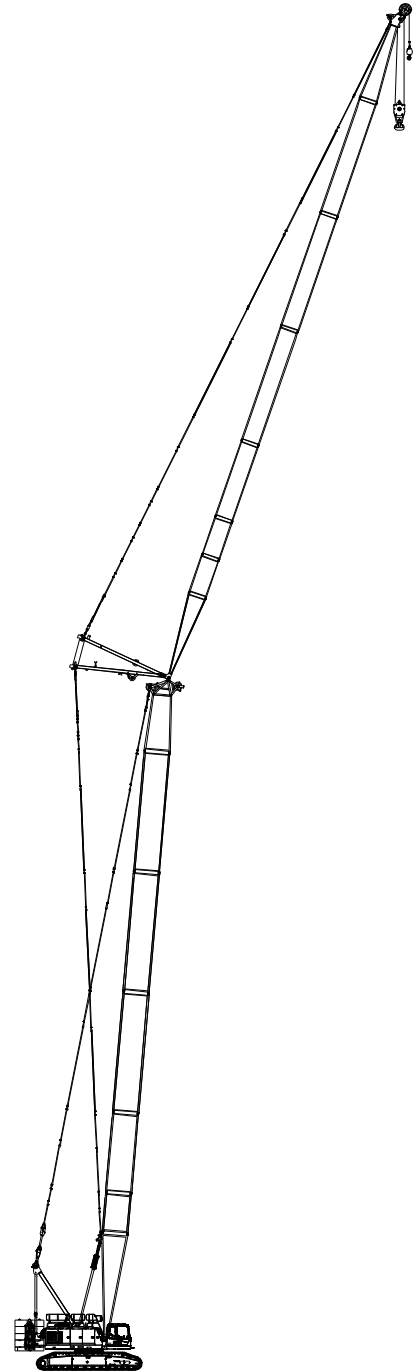
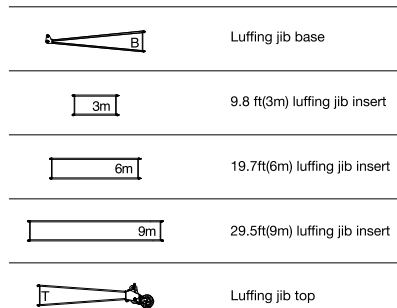

LJ Configuration:
160.8ft+170.6ft (49m+52m)

LJ Working Radius

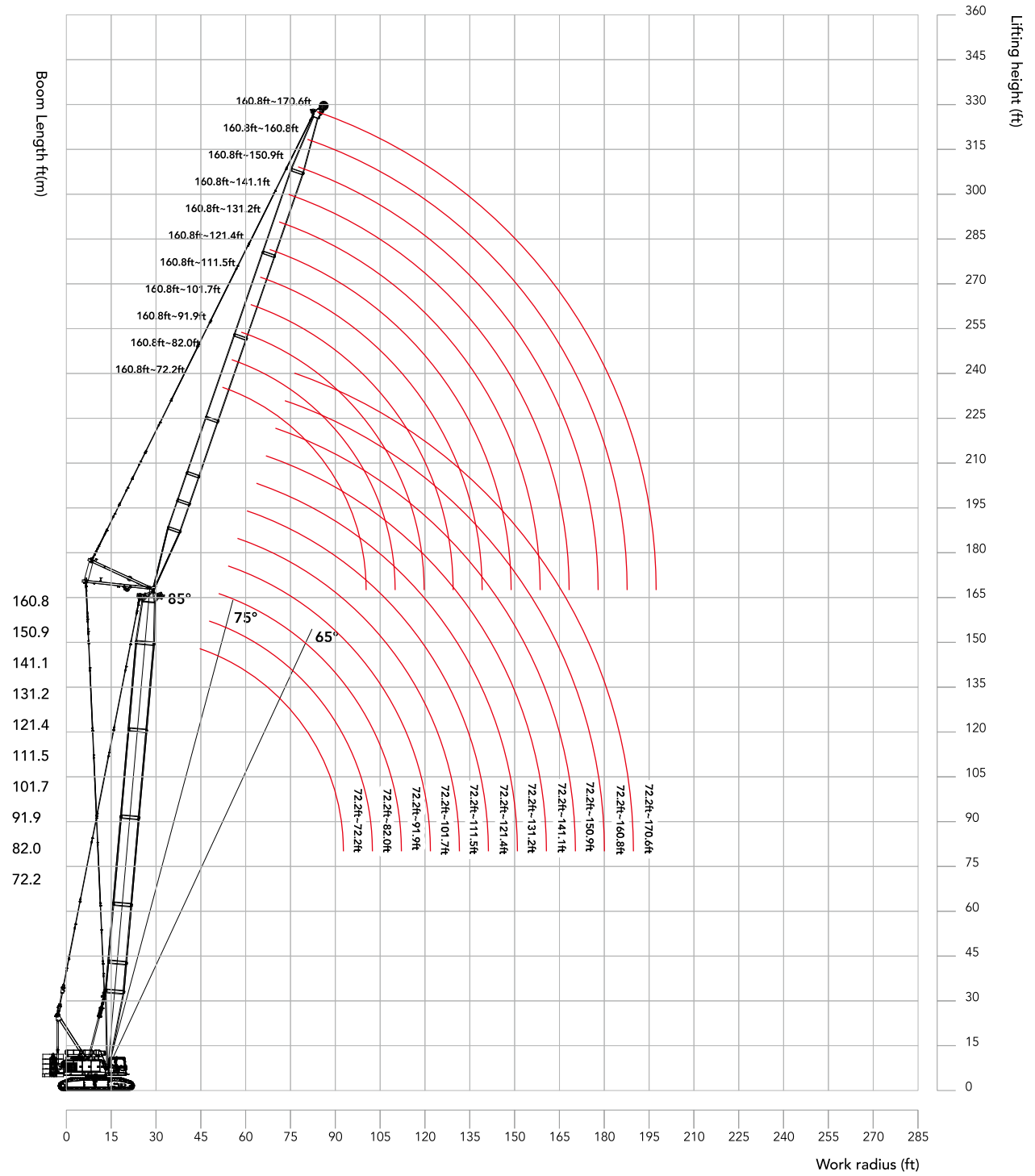

LJ Load Chart

Note:

1. The rated load in the load chart is calculated complying with ASME B30.5;
2. The working radius is the horizontal distance from the load center to the swing center;
3. The actual lifting capacity must subtract the weight of hooks and other riggings from the rated capacity in the load chart.
4. The load value is calculated when the object is hung freely,without considering the influence of wind on the load, ground conditions and slope, operation speed and the influence of any other negative factors over safe operation. Therefore, the operator bears the responsibility of making a judgement and decreasing the load and lowering speed.
5. All ratings are calculated when the machine is parking on firm and level ground with less than 1% gradient.
6. See the Operation Manual for the complete load charts of LJ and LJa configurations.

SCA1350A crawler crane - LJ configuration load chart 1/12

On luffing jib hook, Boom 72.2ft, Boom angle 85°, Rear counterweight 119klbs, Carbody counterweight 44.1klbs, with aux tip extension hook												
Luffing Jib Length (ft) \ Radius (ft)	72.2	82	91.9	101.7	111.5	121.4	131.2	141.1	150.9	160.8	170.6	Luffing Jib Length (ft) \ Radius (ft)
34	872	-	-	-	-	-	-	-	-	-	-	34
36	85.6	-	-	-	-	-	-	-	-	-	-	36
38	84.0	-	-	-	-	-	-	-	-	-	-	38
40	82.2	74.0	65.5	58.5	-	-	-	-	-	-	-	40
45	77.0	69.6	62.1	55.5	-	-	-	-	-	-	-	45
50	70.0	65.6	58.9	52.7	47.4	39.9	-	-	-	-	-	50
55	62.1	60.7	55.6	50.0	46.1	39.0	33.0	27.9	23.9	-	-	55
60	54.2	54.6	52.0	47.4	44.3	38.2	32.3	27.2	23.2	19.9	16.9	60
65	48.1	48.4	48.5	44.8	41.8	37.6	31.4	26.5	22.6	19.3	16.4	65
70	43.3	43.5	43.8	42.3	39.4	36.2	30.7	25.9	22.0	18.7	15.9	70
75	37.5	39.3	39.5	39.1	37.0	34.4	30.0	25.3	21.4	18.2	15.4	75
80	-	35.3	35.8	35.6	34.8	32.3	29.2	24.8	20.8	17.7	14.9	80
85	-	31.3	32.8	32.6	32.7	30.3	27.9	24.3	20.3	17.2	14.6	85
90	-	-	30.1	30.0	30.1	28.6	26.4	23.6	19.8	16.7	14.1	90
95	-	-	26.0	27.7	27.7	26.8	24.8	22.5	19.3	16.2	13.6	95
100	-	-	-	25.3	25.6	25.1	23.3	21.2	18.7	15.7	13.1	100
105	-	-	-	-	23.8	23.8	21.8	20.1	18.1	15.2	12.8	105
110	-	-	-	-	22.0	22.1	20.5	18.7	17.1	14.9	12.5	110
115	-	-	-	-	19.0	20.6	19.2	17.6	15.9	14.2	12.0	115
120	-	-	-	-	-	18.7	18.0	16.5	14.9	13.3	11.5	120
125	-	-	-	-	-	-	16.7	15.4	14.0	12.5	11.0	125
130	-	-	-	-	-	-	15.7	14.4	13.0	11.7	10.1	130
135	-	-	-	-	-	-	13.9	13.3	12.2	10.8	9.4	135
140	-	-	-	-	-	-	-	12.4	11.3	10.0	8.7	140
145	-	-	-	-	-	-	-	-	10.5	9.2	8.1	145
150	-	-	-	-	-	-	-	-	9.6	8.5	7.4	150
155	-	-	-	-	-	-	-	-	8.9	7.8	6.7	155
160	-	-	-	-	-	-	-	-	-	7.2	6.1	160
165	-	-	-	-	-	-	-	-	-	-	5.6	165
170	-	-	-	-	-	-	-	-	-	-	4.9	170
Parts of line	4	3	3	3	2	2	2	1	1	1	1	Parts of line

Unit:klb

LJ Load Chart

SCA1350A crawler crane - LJ configuration load chart 2/12

On luffing jib hook, Boom 72.2ft, Boom angle 85°, Rear counterweight 119klbs, Carbody counterweight 44.1klbs, with aux tip extension hook												
Luffing Jib Length (ft) \ Radius (ft)	72.2	82	91.9	101.7	111.5	121.4	131.2	141.1	150.9	160.8	170.6	Luffing Jib Length (ft) \ Radius (ft)
40	80.7	73.0	63.2	-	-	-	-	-	-	-	-	40
45	72.3	69.3	61.2	-	-	-	-	-	-	-	-	45
50	64.6	63.6	58.7	51.7	44.0	-	-	-	-	-	-	50
55	58.1	57.8	55.7	50.0	43.3	36.7	31.2	26.6	-	-	-	55
60	52.7	52.5	52.2	47.7	42.6	36.1	30.6	26.1	22.4	19.1	-	60
65	48.4	48.2	47.5	45.7	41.8	35.6	30.0	25.6	21.9	18.6	-	65
70	44.6	44.4	43.9	43.2	39.8	34.9	29.4	25.0	21.4	18.1	15.4	70
75	41.3	41.1	40.6	40.4	37.7	34.0	28.8	24.4	20.9	17.7	15.0	75
80	-	38.1	37.7	37.4	35.6	32.9	28.3	23.9	20.4	17.3	14.6	80
85	-	35.4	35.2	34.6	33.2	31.2	27.8	23.4	19.9	16.8	14.1	85
90	-	31.0	32.4	31.9	30.9	29.3	27.0	22.9	19.4	16.3	13.8	90
95	-	-	29.4	29.2	28.6	27.5	25.7	22.5	18.9	15.9	13.4	95
100	-	-	-	26.6	26.4	25.7	24.3	21.9	18.4	15.5	12.9	100
105	-	-	-	24.2	24.2	24.0	22.9	20.7	18.1	15.0	12.6	105
110	-	-	-	22.2	22.4	22.3	21.6	19.7	17.6	14.7	12.2	110
115	-	-	-	-	20.7	20.8	20.2	18.5	16.7	14.3	11.9	115
120	-	-	-	-	-	19.2	18.9	17.3	15.7	13.9	11.6	120
125	-	-	-	-	-	17.5	17.6	16.2	14.7	13.2	11.2	125
130	-	-	-	-	-	16.2	16.4	15.2	13.9	12.3	10.7	130
135	-	-	-	-	-	-	15.2	14.2	13.0	11.5	9.9	135
140	-	-	-	-	-	-	-	13.3	12.2	10.7	9.2	140
145	-	-	-	-	-	-	-	-	11.4	10.1	8.5	145
150	-	-	-	-	-	-	-	-	10.5	9.4	7.8	150
155	-	-	-	-	-	-	-	-	9.7	8.6	7.3	155
160	-	-	-	-	-	-	-	-	-	7.8	6.7	160
165	-	-	-	-	-	-	-	-	-	-	6.1	165
170	-	-	-	-	-	-	-	-	-	-	5.6	170
175	-	-	-	-	-	-	-	-	-	-	4.9	175
Parts of line	4	3	3	2	2	2	2	2	1	1	1	Parts of line

LJ Load Chart

SCA1350A crawler crane - LJ configuration load chart 3/12

On luffing jib hook, Boom 72.2ft, Boom angle 85°, Rear counterweight 119klbs, Carbody counterweight 44.1klbs, with aux tip extension hook												
Luffing Jib Length (ft)	72.2	82	91.9	101.7	111.5	121.4	131.2	141.1	150.9	160.8	170.6	Luffing Jib Length (ft)
Radius (ft)												Radius (ft)
40	69.9	62.5	-	-	-	-	-	-	-	-	-	40
45	64.5	60.0	-	-	-	-	-	-	-	-	-	45
50	58.4	56.4	51.8	46.0	-	-	-	-	-	-	-	50
55	52.6	52.0	49.4	44.7	39.0	33.5	28.9	-	-	-	-	55
60	47.6	47.3	46.7	42.8	38.4	33.0	28.3	24.4	21.1	-	-	60
65	43.9	43.3	43.0	40.4	37.2	32.5	27.8	23.9	20.6	-	-	65
70	40.6	40.0	39.6	38.2	35.4	32.1	27.5	23.5	20.2	17.2	14.7	70
75	37.5	37.1	36.6	35.9	33.6	31.1	27.1	23.1	19.8	16.8	14.4	75
80	34.7	34.4	34.0	33.6	31.7	29.6	26.6	22.6	19.3	16.5	14.0	80
85	32.3	31.9	31.7	31.4	29.9	28.1	26.0	22.3	19.0	16.1	13.7	85
90	-	29.8	29.5	29.1	28.0	26.6	24.7	21.8	18.5	15.8	13.4	90
95	-	-	27.3	26.8	26.2	25.1	23.5	21.4	18.1	15.3	13.0	95
100	-	-	25.0	24.8	24.3	23.6	22.3	20.8	17.8	14.9	12.7	100
105	-	-	-	22.9	22.5	22.0	21.2	19.8	17.4	14.6	12.3	105
110	-	-	-	20.9	21.0	20.5	19.8	18.8	17.1	14.2	12.0	110
115	-	-	-	-	19.5	19.1	18.6	17.8	16.6	13.9	11.7	115
120	-	-	-	-	17.9	17.8	17.4	16.9	16.0	13.6	11.3	120
125	-	-	-	-	-	16.7	16.2	16.0	15.2	13.4	11.0	125
130	-	-	-	-	-	15.3	15.2	15.0	14.3	12.7	10.7	130
135	-	-	-	-	-	-	14.2	14.1	13.5	11.9	10.2	135
140	-	-	-	-	-	-	-	13.2	12.6	11.1	9.6	140
145	-	-	-	-	-	-	-	12.2	11.8	10.3	8.9	145
150	-	-	-	-	-	-	-	11.4	11.1	9.6	8.3	150
155	-	-	-	-	-	-	-	-	10.2	8.9	7.6	155
160	-	-	-	-	-	-	-	-	-	8.3	7.0	160
165	-	-	-	-	-	-	-	-	-	7.6	6.5	165
170	-	-	-	-	-	-	-	-	-	7.1	6.0	170
175	-	-	-	-	-	-	-	-	-	-	5.4	175
Parts of line	3	3	3	2	2	2	2	1	1	1	1	Parts of line

Unit:klb

LJ Load Chart

SCA1350A crawler crane - LJ configuration load chart 4/12

On luffing jib hook, Boom 72.2ft, Boom angle 85°, Rear counterweight 119klbs, Carbody counterweight 44.1klbs, with aux tip extension hook												
Luffing Jib Length (ft) \ Radius (ft)	72.2	82	91.9	101.7	111.5	121.4	131.2	141.1	150.9	160.8	170.6	Luffing Jib Length (ft) \ Radius (ft)
50	51.5	47.4	43.4	-	-	-	-	-	-	-	-	50
55	47.9	45.0	41.6	37.9	33.7	29.4	-	-	-	-	-	55
60	43.6	42.5	39.7	36.5	33.1	29.0	25.3	22.0	-	-	-	60
65	40.1	39.8	37.5	35.0	32.1	28.7	25.0	21.6	-	-	-	65
70	37.2	36.8	35.5	33.1	30.8	28.1	24.6	21.3	18.4	16.0	13.8	70
75	34.4	34.0	33.4	31.1	29.3	27.2	24.2	21.0	18.1	15.7	13.5	75
80	31.9	31.5	31.2	29.3	27.8	26.1	23.6	20.6	17.8	15.3	13.1	80
85	29.9	29.4	29.0	27.4	26.3	24.8	23.0	20.3	17.4	15.0	12.8	85
90	-	27.4	27.0	25.9	24.8	23.6	22.0	20.0	17.1	14.7	12.5	90
95	-	25.4	25.0	24.2	23.3	22.3	21.0	19.4	16.8	14.3	12.1	95
100	-	-	23.1	22.4	21.8	21.0	20.0	18.7	16.5	14.0	11.9	100
105	-	-	-	20.9	20.5	19.8	19.0	17.9	16.3	13.7	11.7	105
110	-	-	-	19.4	19.2	18.7	17.9	17.0	15.8	13.5	11.3	110
115	-	-	-	-	17.8	17.5	16.9	16.2	15.2	13.2	11.0	115
120	-	-	-	-	16.5	16.4	15.9	15.3	14.5	12.9	10.7	120
125	-	-	-	-	-	15.4	14.9	14.5	13.8	12.6	10.6	125
130	-	-	-	-	-	14.4	14.1	13.7	13.2	12.4	10.2	130
135	-	-	-	-	-	-	13.1	12.8	12.5	11.8	10.0	135
140	-	-	-	-	-	-	12.3	12.0	11.8	11.2	9.7	140
145	-	-	-	-	-	-	-	11.4	11.2	10.7	9.2	145
150	-	-	-	-	-	-	-	10.7	10.5	10.0	8.7	150
155	-	-	-	-	-	-	-	-	9.8	9.4	8.0	155
160	-	-	-	-	-	-	-	-	9.2	8.7	7.4	160
165	-	-	-	-	-	-	-	-	-	8.0	6.7	165
170	-	-	-	-	-	-	-	-	-	7.4	6.2	170
175	-	-	-	-	-	-	-	-	-	-	5.7	175
180	-	-	-	-	-	-	-	-	-	-	5.2	180
Parts of line	3	2	2	2	2	2	1	1	1	1	1	Parts of line

LJ Load Chart

SCA1350A crawler crane - LJ configuration load chart 5/12												
On luffing jib hook, Boom 72.2ft, Boom angle 85°, Rear counterweight 119klbs, Carbody counterweight 44.1klbs, with aux tip extension hook												
Luffing Jib Length (ft) \ Radius (ft)	72.2	82	91.9	101.7	111.5	121.4	131.2	141.1	150.9	160.8	170.6	Luffing Jib Length (ft) \ Radius (ft)
60	67.0	-	-	-	-	-	-	-	-	-	-	60
65	60.9	-	-	-	-	-	-	-	-	-	-	65
70	56.1	55.9	54.8	-	-	-	-	-	-	-	-	70
75	51.8	51.5	51.5	47.2	-	-	-	-	-	-	-	75
80	48.0	47.6	47.9	45.3	40.7	33.9	-	-	-	-	-	80
85	44.5	44.3	44.5	42.9	39.5	33.5	-	-	-	-	-	85
90	39.2	41.2	41.5	40.7	37.4	33.0	27.5	23.1	-	-	-	90
95	-	37.5	38.4	38.2	35.4	32.2	27.1	22.7	19.1	-	-	95
100	-	-	35.3	35.4	33.5	31.0	26.7	22.3	18.6	15.8	13.1	100
105	-	-	31.9	32.4	31.5	29.3	26.2	21.8	18.3	15.4	12.8	105
110	-	-	28.1	29.7	29.8	27.6	25.2	21.5	18.0	14.9	12.5	110
115	-	-	-	27.0	27.9	26.1	23.9	21.0	17.6	14.5	12.1	115
120	-	-	-	-	25.8	24.5	22.4	20.3	17.3	14.3	11.8	120
125	-	-	-	-	23.6	22.8	21.1	19.1	16.9	14.1	11.5	125
130	-	-	-	-	20.8	21.3	19.7	18.1	16.3	13.8	11.3	130
135	-	-	-	-	-	19.9	18.5	17.0	15.3	13.4	11.0	135
140	-	-	-	-	-	-	17.3	15.9	14.4	12.9	10.7	140
145	-	-	-	-	-	-	16.2	14.9	13.6	12.0	10.3	145
150	-	-	-	-	-	-	15.0	13.8	12.7	11.2	9.6	150
155	-	-	-	-	-	-	-	12.8	11.7	10.3	8.9	155
160	-	-	-	-	-	-	-	-	10.9	9.6	8.3	160
165	-	-	-	-	-	-	-	-	-	8.9	7.6	165
170	-	-	-	-	-	-	-	-	-	8.0	6.9	170
175	-	-	-	-	-	-	-	-	-	7.5	6.4	175
180	-	-	-	-	-	-	-	-	-	-	5.8	180
Parts of line	3	3	3	2	2	2	2	1	1	1	1	Parts of line

Unit:klb

LJ Load Chart

SCA1350A crawler crane - LJ configuration load chart 6/12

On luffing jib hook, Boom 72.2ft, Boom angle 85°, Rear counterweight 119klbs, Carbody counterweight 44.1klbs, with aux tip extension hook												
Luffing Jib Length (ft) \ Radius (ft)	72.2	82	91.9	101.7	111.5	121.4	131.2	141.1	150.9	160.8	170.6	Luffing Jib Length (ft) \ Radius (ft)
70	47.6	-	-	-	-	-	-	-	-	-	-	70
75	44.0	43.2	43.1	-	-	-	-	-	-	-	-	75
80	40.7	39.9	39.7	39.8	-	-	-	-	-	-	-	80
85	37.7	37.2	37.0	37.0	-	-	-	-	-	-	-	85
90	35.3	34.8	34.6	34.6	34.0	31.7	-	-	-	-	-	90
95	33.0	32.8	32.5	32.4	31.8	31.0	26.2	-	-	-	-	95
100	-	30.9	30.6	30.3	29.9	29.8	25.9	21.7	18.4	-	-	100
105	-	28.9	28.9	28.4	28.2	28.0	25.6	21.4	18.1	15.2	12.8	105
110	-	27.5	27.2	26.9	26.7	26.5	25.2	21.0	17.7	14.9	12.5	110
115	-	-	25.7	25.5	25.2	25.0	24.6	20.8	17.4	14.5	12.1	115
120	-	-	-	24.2	23.9	23.6	23.5	20.6	17.1	14.2	11.8	120
125	-	-	-	-	22.8	22.4	22.2	20.3	16.7	13.9	11.7	125
130	-	-	-	-	21.5	21.2	20.8	19.9	16.4	13.7	11.3	130
135	-	-	-	-	20.5	20.2	19.9	19.0	16.2	13.4	11.0	135
140	-	-	-	-	-	19.2	19.0	17.8	15.8	13.2	10.7	140
145	-	-	-	-	-	-	18.0	16.6	15.1	12.9	10.5	145
150	-	-	-	-	-	-	17.3	15.6	14.3	12.4	10.2	150
155	-	-	-	-	-	-	16.2	14.7	13.4	11.8	10.0	155
160	-	-	-	-	-	-	-	13.8	12.6	11.1	9.6	160
165	-	-	-	-	-	-	-	-	11.7	10.4	8.9	165
170	-	-	-	-	-	-	-	-	10.9	9.6	8.2	170
175	-	-	-	-	-	-	-	-	10.1	8.9	7.6	175
180	-	-	-	-	-	-	-	-	-	8.2	6.9	180
185	-	-	-	-	-	-	-	-	-	-	6.3	185
190	-	-	-	-	-	-	-	-	-	-	5.8	190
195	-	-	-	-	-	-	-	-	-	-	5.3	195
Parts of line	2	2	2	2	2	2	1	1	1	1	1	Parts of line

LJ Load Chart

SCA1350A crawler crane - LJ configuration load chart 7/12												
On luffing jib hook, Boom 72.2ft, Boom angle 85°, Rear counterweight 119klbs, Carbody counterweight 44.1klbs, with aux tip extension hook												
Luffing Jib Length (ft) \ Radius (ft)	72.2	82	91.9	101.7	111.5	121.4	131.2	141.1	150.9	160.8	170.6	Luffing Jib Length (ft) \ Radius (ft)
75	38.2	-	-	-	-	-	-	-	-	-	-	75
80	35.3	35.3	-	-	-	-	-	-	-	-	-	80
85	33.0	32.6	-	-	-	-	-	-	-	-	-	85
90	31.0	30.5	30.3	29.9	-	-	-	-	-	-	-	90
95	29.0	28.7	28.5	27.9	27.7	27.3	-	-	-	-	-	95
100	27.3	27.0	26.8	26.3	26.0	25.5	24.4	-	-	-	-	100
105	-	25.3	25.1	24.9	24.5	24.0	23.6	20.5	17.4	-	-	105
110	-	23.8	23.8	23.4	23.0	22.7	22.2	20.3	17.1	-	-	110
115	-	22.6	22.4	22.1	21.7	21.5	21.0	20.1	16.9	14.2	-	115
120	-	-	21.2	20.9	20.6	20.3	19.9	19.5	16.6	14.0	11.6	120
125	-	-	-	19.8	19.6	19.1	18.9	18.5	16.3	13.7	11.5	125
130	-	-	-	18.8	18.5	18.3	18.1	17.6	16.1	13.5	11.3	130
135	-	-	-	17.9	17.7	17.3	17.1	16.8	16.0	13.2	11.0	135
140	-	-	-	-	16.8	16.5	16.2	15.9	15.6	12.9	10.7	140
145	-	-	-	-	-	15.8	15.3	15.1	14.9	12.8	10.5	145
150	-	-	-	-	-	15.1	14.7	14.3	14.0	12.6	10.2	150
155	-	-	-	-	-	-	14.1	13.7	13.3	12.3	10.0	155
160	-	-	-	-	-	-	13.5	13.1	12.7	12.0	9.8	160
165	-	-	-	-	-	-	-	12.5	12.1	11.5	9.6	165
170	-	-	-	-	-	-	-	12.0	11.7	10.7	9.1	170
175	-	-	-	-	-	-	-	-	11.1	10.0	8.6	175
180	-	-	-	-	-	-	-	-	10.5	9.3	8.0	180
185	-	-	-	-	-	-	-	-	-	8.6	7.3	185
190	-	-	-	-	-	-	-	-	-	8.0	6.6	190
195	-	-	-	-	-	-	-	-	-	-	6.1	195
200	-	-	-	-	-	-	-	-	-	-	5.6	200
Parts of line	2	2	2	2	2	2	1	1	1	1	1	Parts of line

Unit:klb

LJ Load Chart

SCA1350A crawler crane - LJ configuration load chart 8/12

On luffing jib hook, Boom 72.2ft, Boom angle 85°, Rear counterweight 119klbs, Carbody counterweight 44.1klbs, with aux tip extension hook												
Luffing Jib Length (ft) \ Radius (ft)	72.2	82	91.9	101.7	111.5	121.4	131.2	141.1	150.9	160.8	170.6	Luffing Jib Length (ft) \ Radius (ft)
80	31.3	-	-	-	-	-	-	-	-	-	-	80
85	28.8	-	-	-	-	-	-	-	-	-	-	85
90	27.1	26.9	-	-	-	-	-	-	-	-	-	90
95	25.4	25.1	24.7	24.3	-	-	-	-	-	-	-	95
100	23.8	23.4	23.3	22.7	22.4	-	-	-	-	-	-	100
105	22.5	22.0	21.8	21.4	20.9	20.7	20.3	-	-	-	-	105
110	21.3	20.7	20.5	20.2	19.8	19.4	18.9	-	-	-	-	110
115	-	19.7	19.4	19.1	18.7	18.3	17.8	17.6	-	-	-	115
120	-	18.7	18.4	18.1	17.7	17.3	16.8	16.5	15.5	13.2	-	120
125	-	-	17.4	16.9	16.7	16.5	15.8	15.4	15.2	13.0	11.0	125
130	-	-	16.7	16.3	15.9	15.5	15.0	14.7	14.5	12.8	10.8	130
135	-	-	-	15.5	15.0	14.7	14.4	14.0	13.7	12.7	10.5	135
140	-	-	-	14.6	14.3	14.0	13.7	13.3	12.9	12.3	10.3	140
145	-	-	-	-	13.6	13.4	12.9	12.5	12.3	11.8	10.1	145
150	-	-	-	-	12.9	12.7	12.2	11.8	11.6	11.1	10.0	150
155	-	-	-	-	-	12.2	11.7	11.3	11.1	10.6	9.8	155
160	-	-	-	-	-	11.6	11.1	10.8	10.5	10.1	9.5	160
165	-	-	-	-	-	-	10.5	10.3	10.0	9.6	9.2	165
170	-	-	-	-	-	-	10.2	9.8	9.5	9.3	8.7	170
175	-	-	-	-	-	-	-	9.4	9.0	8.8	8.5	175
180	-	-	-	-	-	-	-	9.0	8.6	8.3	8.1	180
185	-	-	-	-	-	-	-	-	8.3	7.8	7.6	185
190	-	-	-	-	-	-	-	-	8.0	7.5	7.1	190
195	-	-	-	-	-	-	-	-	-	7.2	6.7	195
200	-	-	-	-	-	-	-	-	-	-	6.4	200
205	-	-	-	-	-	-	-	-	-	-	6.0	205
Parts of line	2	2	1	1	1	1	1	1	1	1	1	Parts of line

LJ Load Chart

SCA1350A crawler crane - LJ configuration load chart 9/12

On luffing jib hook, Boom 72.2ft, Boom angle 85°, Rear counterweight 119klbs, Carbody counterweight 44.1klbs, with aux tip extension hook												
Luffing Jib Length (ft)	72.2	82	91.9	101.7	111.5	121.4	131.2	141.1	150.9	160.8	170.6	Luffing Jib Length (ft)
Radius (ft)												Radius (ft)
80	48.5	-	-	-	-	-	-	-	-	-	-	80
85	45.0	-	-	-	-	-	-	-	-	-	-	85
90	42.1	41.7	-	-	-	-	-	-	-	-	-	90
95	39.4	39.0	38.8	-	-	-	-	-	-	-	-	95
100	37.0	36.6	36.4	36.1	-	-	-	-	-	-	-	100
105	-	34.6	34.4	33.9	33.7	-	-	-	-	-	-	105
110	-	32.6	32.4	32.1	31.9	-	-	-	-	-	-	110
115	-	-	30.7	30.4	30.1	28.8	-	-	-	-	-	115
120	-	-	29.2	28.7	28.5	28.1	23.5	19.6	-	-	-	120
125	-	-	-	27.3	27.0	26.8	23.4	19.4	16.1	-	-	125
130	-	-	-	26.1	25.9	25.6	23.4	19.2	15.7	-	-	130
135	-	-	-	-	24.7	24.5	22.5	18.9	15.5	12.9	-	135
140	-	-	-	-	23.2	23.2	21.2	18.5	15.4	12.7	10.4	140
145	-	-	-	-	-	21.9	19.9	17.9	15.2	12.5	10.1	145
150	-	-	-	-	-	20.5	18.7	16.9	15.0	12.2	10.0	150
155	-	-	-	-	-	-	17.6	15.9	14.4	12.0	9.8	155
160	-	-	-	-	-	-	-	14.9	13.6	11.6	-	160
165	-	-	-	-	-	-	-	13.9	12.6	-	-	165
170	-	-	-	-	-	-	-	13.1	11.8	-	-	170
Parts of line	2	2	2	2	2	2	1	1	1	1	1	Parts of line

Unit:klb

LJ Load Chart

SCA1350A crawler crane - LJ configuration load chart 10/12

On luffing jib hook, Boom 72.2ft, Boom angle 85°, Rear counterweight 119klbs, Carbody counterweight 44.1klbs, with aux tip extension hook												
Luffing Jib Length (ft) \ Radius (ft)	72.2	82	91.9	101.7	111.5	121.4	131.2	141.1	150.9	160.8	170.6	Luffing Jib Length (ft) \ Radius (ft)
95	33.2	-	-	-	-	-	-	-	-	-	-	95
100	31.2	31.0	-	-	-	-	-	-	-	-	-	100
105	29.5	29.3	28.9	-	-	-	-	-	-	-	-	105
110	27.9	27.5	27.2	-	-	-	-	-	-	-	-	110
115	26.3	26.0	25.7	25.3	-	-	-	-	-	-	-	115
120	-	24.7	24.4	24.0	23.6	-	-	-	-	-	-	120
125	-	-	23.1	22.9	22.4	22.4	-	-	-	-	-	125
130	-	-	21.9	21.9	21.4	21.0	-	-	-	-	-	130
135	-	-	20.8	20.7	20.4	20.1	19.7	18.4	-	-	-	135
140	-	-	-	19.7	19.5	19.2	18.7	18.1	15.1	-	-	140
145	-	-	-	-	18.6	18.4	17.8	17.5	15.0	12.3	-	145
150	-	-	-	-	17.6	17.6	17.1	16.7	14.8	12.2	-	150
155	-	-	-	-	-	16.7	16.3	16.0	14.6	12.0	9.8	155
160	-	-	-	-	-	16.0	15.5	15.3	14.5	11.8	9.6	160
165	-	-	-	-	-	-	14.9	14.6	14.2	11.7	9.4	165
170	-	-	-	-	-	-	14.2	14.0	13.7	11.5	9.3	170
175	-	-	-	-	-	-	-	13.3	13.1	11.3	9.1	175
180	-	-	-	-	-	-	-	12.7	12.4	11.0	8.9	180
185	-	-	-	-	-	-	-	-	11.7	10.4	8.7	185
190	-	-	-	-	-	-	-	-	11.1	9.7	8.2	190
195	-	-	-	-	-	-	-	-	-	9.1	-	195
Parts of line	2	2	2	1	1	1	1	1	1	1	1	Parts of line

LJ Load Chart

SCA1350A crawler crane - LJ configuration load chart 11/12												
On luffing jib hook, Boom 72.2ft, Boom angle 85°, Rear counterweight 119klbs, Carbody counterweight 44.1klbs, with aux tip extension hook												
Luffing Jib Length (ft) \ Radius (ft)	72.2	82	91.9	101.7	111.5	121.4	131.2	141.1	150.9	160.8	170.6	Luffing Jib Length (ft) \ Radius (ft)
105	25.1	-	-	-	-	-	-	-	-	-	-	105
110	23.6	-	-	-	-	-	-	-	-	-	-	110
115	22.2	22.1	-	-	-	-	-	-	-	-	-	115
120	21.0	20.9	20.6	-	-	-	-	-	-	-	-	120
125	20.0	19.6	19.5	18.9	-	-	-	-	-	-	-	125
130	19.0	18.7	18.4	17.9	-	-	-	-	-	-	-	130
135	-	17.8	17.4	17.1	16.8	-	-	-	-	-	-	135
140	-	-	16.6	16.4	15.9	15.6	15.1	-	-	-	-	140
145	-	-	-	15.6	15.1	14.9	14.5	14.0	-	-	-	145
150	-	-	-	14.9	14.5	14.0	13.8	13.3	-	-	-	150
155	-	-	-	14.2	13.8	13.5	13.1	12.7	12.5	-	-	155
160	-	-	-	-	13.2	13.0	12.4	12.1	11.8	11.4	-	160
165	-	-	-	-	-	12.4	11.8	11.6	11.1	10.9	9.4	165
170	-	-	-	-	-	11.8	11.3	11.1	10.6	10.2	9.3	170
175	-	-	-	-	-	11.1	10.8	10.4	10.1	9.7	9.1	175
180	-	-	-	-	-	-	10.4	9.9	9.6	9.3	8.8	180
185	-	-	-	-	-	-	-	9.6	9.2	9.0	-	185
190	-	-	-	-	-	-	-	9.3	8.8	8.6	-	190
195	-	-	-	-	-	-	-	8.8	8.5	-	-	195
Parts of line	1	1	1	1	1	1	1	1	1	1	1	Parts of line

Unit:klb

LJ Load Chart

SCA1350A crawler crane - LJ configuration load chart 12/12

On luffing jib hook, Boom 72.2ft, Boom angle 85°, Rear counterweight 119klbs, Carbody counterweight 44.1klbs, with aux tip extension hook										
Luffing Jib Length (ft) \ Radius (ft)	72.2	82	91.9	101.7	111.5	121.4	131.2	141.1	150.9	Luffing Jib Length (ft) \ Radius (ft)
120	174	-	-	-	-	-	-	-	-	120
125	16.7	16.2	-	-	-	-	-	-	-	125
130	15.7	15.2	-	-	-	-	-	-	-	130
135	14.9	14.5	14.3	-	-	-	-	-	-	135
140	-	13.8	13.6	12.9	-	-	-	-	-	140
145	-	13.1	12.9	12.3	12.0	11.6	-	-	-	145
150	-	12.5	12.2	12.0	11.4	10.9	-	-	-	150
155	-	-	11.7	11.4	11.0	10.4	9.9	-	-	155
160	-	-	-	10.8	10.5	9.9	9.4	9.0	-	160
165	-	-	-	10.3	9.9	9.4	8.9	8.5	8.3	165
170	-	-	-	10.0	9.5	9.1	8.4	8.2	7.8	170
175	-	-	-	-	8.9	8.4	8.1	7.7	7.4	175
180	-	-	-	-	-	8.0	7.7	7.3	-	180
185	-	-	-	-	-	7.6	7.4	-	-	185
190	-	-	-	-	-	7.3	7.1	-	-	190
Parts of line	1	1	1	1	1	1	1	1	1	Parts of line

Service

When we say that SANY machines are built to endure, we're really talking about service. SANY equipment is intentionally designed to be easily and efficiently serviced, with features such as wide compartment doors and easy access to make maintenance more efficient. Because ease of service means back in service.

We've Got Your Back

To provide peace of mind and ensure maximum uptime, all SANY cranes are backed by a robust 3-year/3,000-hour standard warranty. That's our commitment to keeping your fleet running at peak performance.



SANY America Inc.

318 Cooper Circle

Peachtree City | GA 30269

| T | 470-552-SANY

***WARRANTY APPLIES TO 2022 MODELS**

CRABR22SCA1350A001

[sanyamerica.com](https://www.sanyamerica.com)

In the interest of continual equipment development, SANY America Inc. reserves the right to change these specifications at any time without prior notification.

© 2022 SANY AMERICA INC.